

 The image cannot be displayed. Your computer may not have enough memory to open the image, or the image may have been corrupted. Restart your computer, and then open the file again. If the red x still appears, you may have to delete the image and then insert it again.

*Grain Boundaries,
Misorientation Distributions,
Rodrigues space, Symmetry*

27-750

Texture, Microstructure & Anisotropy,

A.D. Rollett

Last revised: 14th Mar. '16

 The image cannot be displayed. Your computer may not have enough memory to open the image, or the image may have been corrupted. Restart your computer, and then open the file again. If the red x still appears, you may have to delete the image and then insert it again.

Objectives

- Identify the Grain Boundary as an important element of microstructure and focus on the lattice misorientation associated with interfaces.
- Define the *Misorientation Distribution (MD)* or *Misorientation Distribution Function (MDF)* and describe typical features of misorientation distributions and their representations.
- Describe the crystallography of grain boundaries, using the *Rodrigues-Frank vector* [Frank, F. (1988), "Orientation mapping." *Metallurgical Transactions* **19A** 403-408].
- Describe the effect of symmetry on the Rodrigues space; also the shape of the space (i.e. the fundamental zone) required to describe a unique set of grain boundary types in Rodrigues space, axis-angle space and Euler space.
- The discussion provided here is entirely in terms of cubic crystal symmetry. Obviously the details change for different classes of crystal symmetry.
- Overall objective of the discussion of grain boundaries is to illustrate the power of gathering data on a statistical basis, which complements the more traditional approach of studying high symmetry boundaries in the transmission electron microscope.

Reading

- Pages 3-25 of Sutton & Balluffi
- Pages 307-346 of Howe
- Frank, F. (1988), "Orientation mapping."
Metallurgical Transactions **19A** 403-408
- Zhao, J. and B. L. Adams (1988).
"Definition of an asymmetric domain for
intercrystalline misorientation in cubic
materials in the space of Euler angles."
Acta Crystallographica **A44** 326-336

Grain Boundaries

- Where crystals or grains join together, the crystal lattice cannot be perfect and therefore a grain boundary exists. At the atomistic scale, each boundary is obvious as a discontinuity in the atomic packing.

In most crystalline solids, a grain boundary is very thin (one/two atoms).

Disorder (broken bonds) unavoidable for geometrical reasons; therefore large excess free energy ($0.1 - 1 \text{ J.m}^{-2}$).

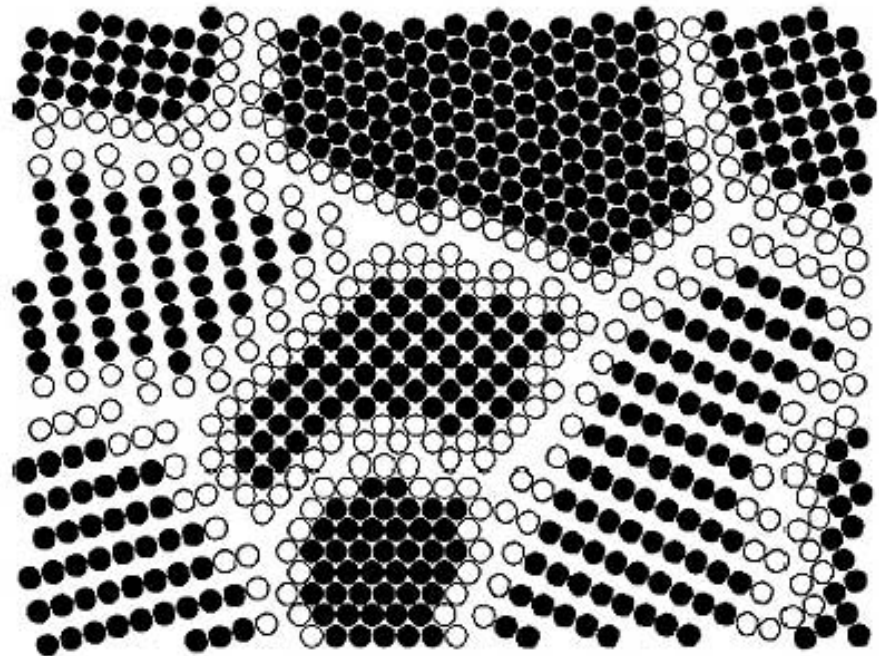

Axis Transformations at a Grain Boundary

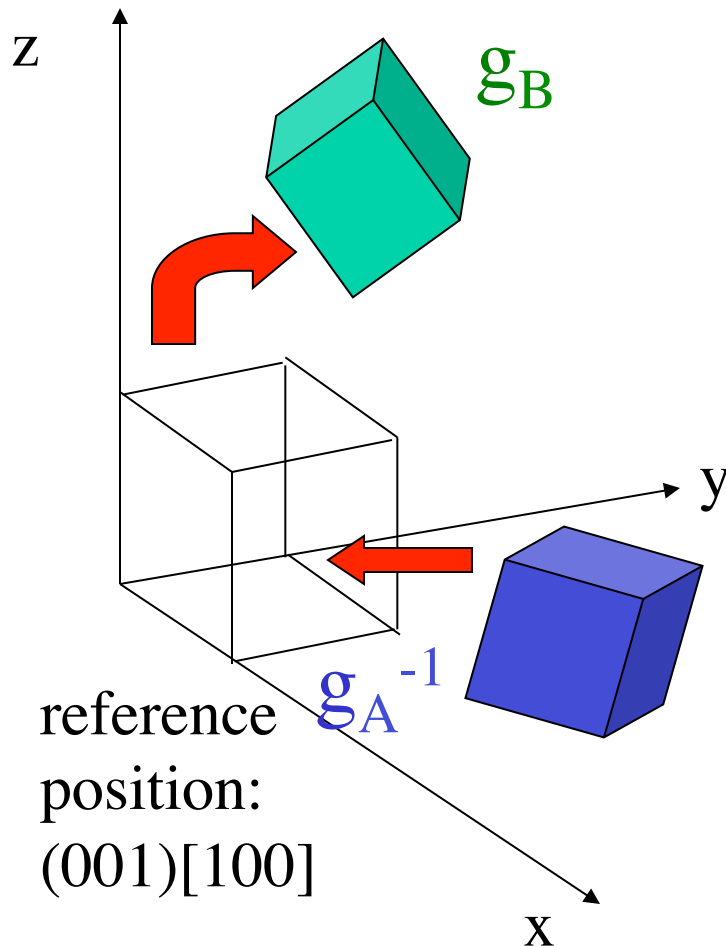

In terms of orientations:
transform *back* from frame A
to the reference position.
Then transform *to* frame B.
Compound (“compose”)
the two transformations to
arrive at the *net*
transformation between the
two grains.

$$\text{Net transformation} = g_B g_A^{-1}$$

NB: these are passive rotations

Misorientation

- Definition of misorientation[†]: given two orientations (grains, crystals), the misorientation is the transformation required to transform tensor quantities (vectors, stress, strain) from one set of crystal axes to the other set [passive rotation].
- Alternate [active rotation*]: given two orientations (grains, crystals), the misorientation is the rotation required to rotate one set of crystal axes into coincidence with the other crystal (based on a fixed reference frame).

* For the active rotation description, the natural choice of reference frame is the set of sample axes. Expressing the misorientation in terms of sample axes, however, will mean that the associated misorientation axis is unrelated to directions in either crystal. In order for the misorientation axis to relate to crystal directions, one must adopt one of the crystals as the reference frame. Confused?! Study the slides and examples that follow!

† In some texts, the word *disorientation* (as opposed to *misorientation*) means the *smallest physically possible rotation* that will connect two orientations. The idea that there is any choice of rotation angle arises because of crystal symmetry: by re-labeling axes (in either crystal), the net rotation changes.

Why are grain boundaries interesting, important?

- Grain boundaries vary a great deal in their characteristics (energy, mobility, chemistry).
- Many properties of a material - and also processes of microstructural evolution - depend on the nature of the grain boundaries.
- Materials can be made to have good or bad corrosion properties, mechanical properties (creep) depending on the type of grain boundaries present.
- Some grain boundaries exhibit good atomic fit and are therefore resistant to sliding, show low diffusion rates, low energy, etc.

Degrees of (Geometric) Freedom

- Grain boundaries have 5 degrees of freedom in terms of their macroscopic geometry: *either* 3 parameters to specify a rotation between the lattices plus 2 parameters to specify the boundary plane; *or* 2 parameters for each boundary plane on each side of the boundary (total of 4) plus a twist angle (1 parameter) between the lattices.
- In addition to the macroscopic degrees of freedom, grain boundaries have 3 degrees of microscopic freedom (not considered here). The lattices can be translated in the plane of the boundary, and they can move towards/away from each other along the boundary normal.
- If the orientation of a boundary with respect to *sample axes* matters (e.g. because of an applied stress, or magnetic field), then an additional 2 parameters must be specified.

1 / 2 / 3 / 5 -parameter GB Character

<http://mimp.materials.cmu.edu>

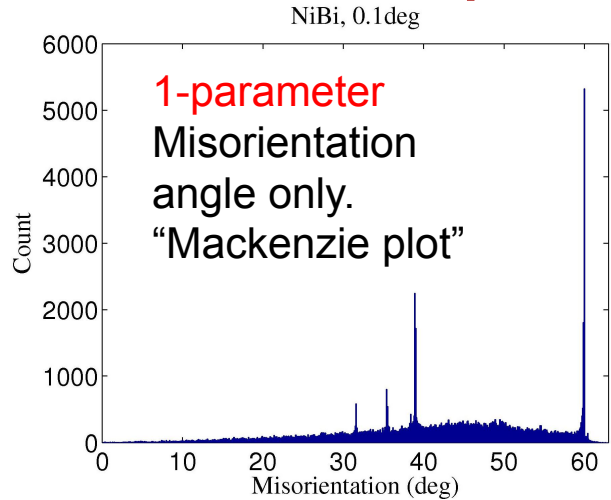

5-parameter
Grain Boundary Character
Distribution – "GBCD".
Each misorientation type
expands to a stereogram that
shows variation in frequency of
GB normals.

2-parameter
Grain Boundary Plane
Distribution – "GBPD".
Shows variation in
frequency of
GB normals only,
averaged over
misorientation.

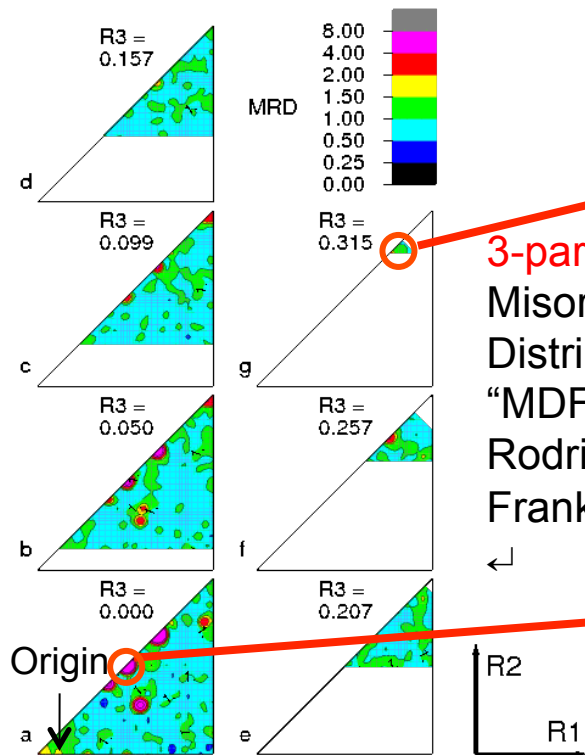

3-parameter
Misorientation
Distribution
"MDF"
Rodrigues-
Frank space

1.0 1.0 1.0 60.0

Σ_3

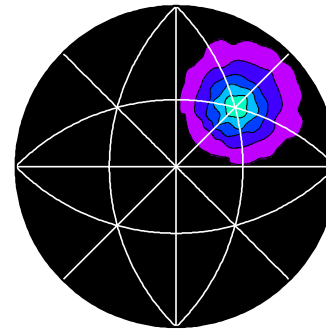

1.0 1.0 0.0 38.9

Σ_9

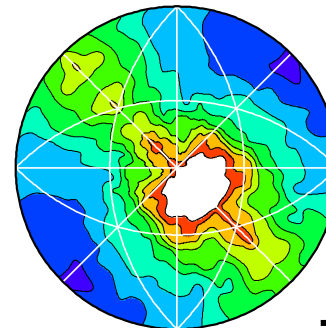

Example: Bi-doped Ni

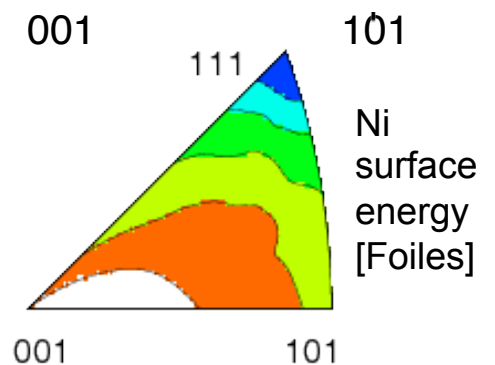
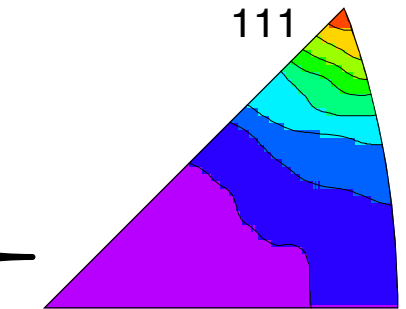

Boundary Type

- There are several ways of describing grain boundaries.
- A traditional method (in materials science) uses the tilt-twist description.
- A *twist boundary* is one in which one crystal has been twisted about an axis *perpendicular to the boundary plane*, relative to the other crystal.
- A *tilt boundary* is one in which one crystal has been twisted about an axis that lies *in the boundary plane*, relative to the other crystal.
- More general boundaries have a combination of tilt and twist.
- The approach specifies all five degrees of freedom.
- Contrast with more recent (EBSD inspired) method that describes *only the misorientation* between the two crystals.
- The Grain Boundary Character Distribution, GBCD, method, developed at CMU, uses *misorientation+normal* to characterize grain boundaries.

Tilt versus Twist Boundary Types

- Tilt boundary is a rotation about an axis in the boundary plane. Thus the misorientation axis is *perpendicular* to the GB normal.
- Twist boundary is a rotation about an axis perpendicular to the plane. Thus the misorientation axis is *parallel* to the GB normal.

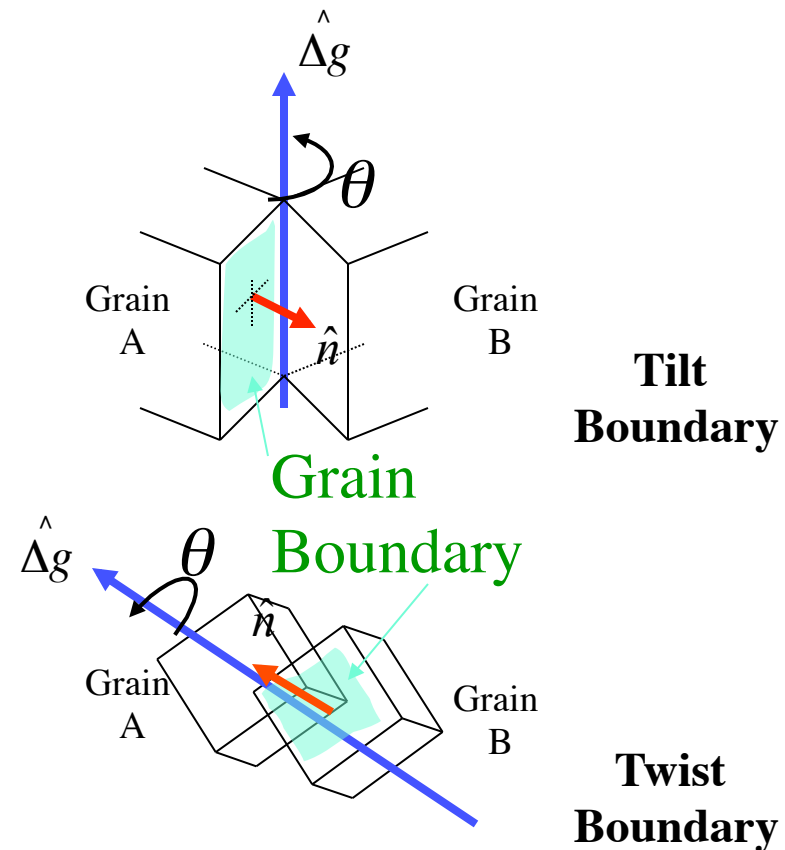

NB: the tilt or twist angle is *not* necessarily the same as the minimum misorientation angle (although for low angle boundaries, it typically is so).

How to construct a grain boundary

- There are many ways to put together a grain boundary.
- There is always a common crystallographic axis between the two grains: one can therefore think of turning one piece of crystal relative to the other about this common axis. This is the *misorientation* concept. A further decision is required in order to determine the boundary plane.
- Alternatively, one can think of cutting a particular facet on each of the two grains, and then rotating one of them to match up with the other. This leads to the *tilt/twist* concept.
- The choice of the particular facet defines the GB normal, and the rotation defines the misorientation.
- Note: the misorientation axis is, in general, unrelated to the boundary plane.

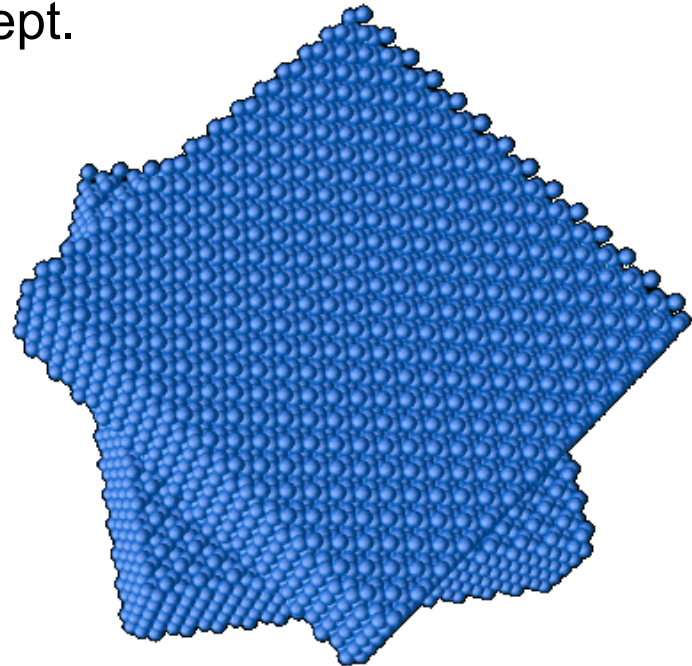

http://www.lce.hut.fi/research/eas/nanosystems/proj_gb/

Differences in Orientation

- Preparation for the math of misorientations: the difference in orientation between two grains is a transformation, just as an orientation is the transformation that describes a texture component.
- Convention: we use different methods (axis-angle , or Rodrigues vectors) to describe GB misorientation than we do for texture. This is because the rotation axis is often important in terms of its crystallographic alignment (by contrast to orientations, where it is generally of minor interest).
- Note that we could use Euler angles for everything, – see for example Zhao, J. and B. L. Adams (1988). "Definition of an asymmetric domain for intercrystalline misorientation in cubic materials in the space of Euler angles." *Acta Crystallographica* **A44**: 326-336.

Alternate Diagram

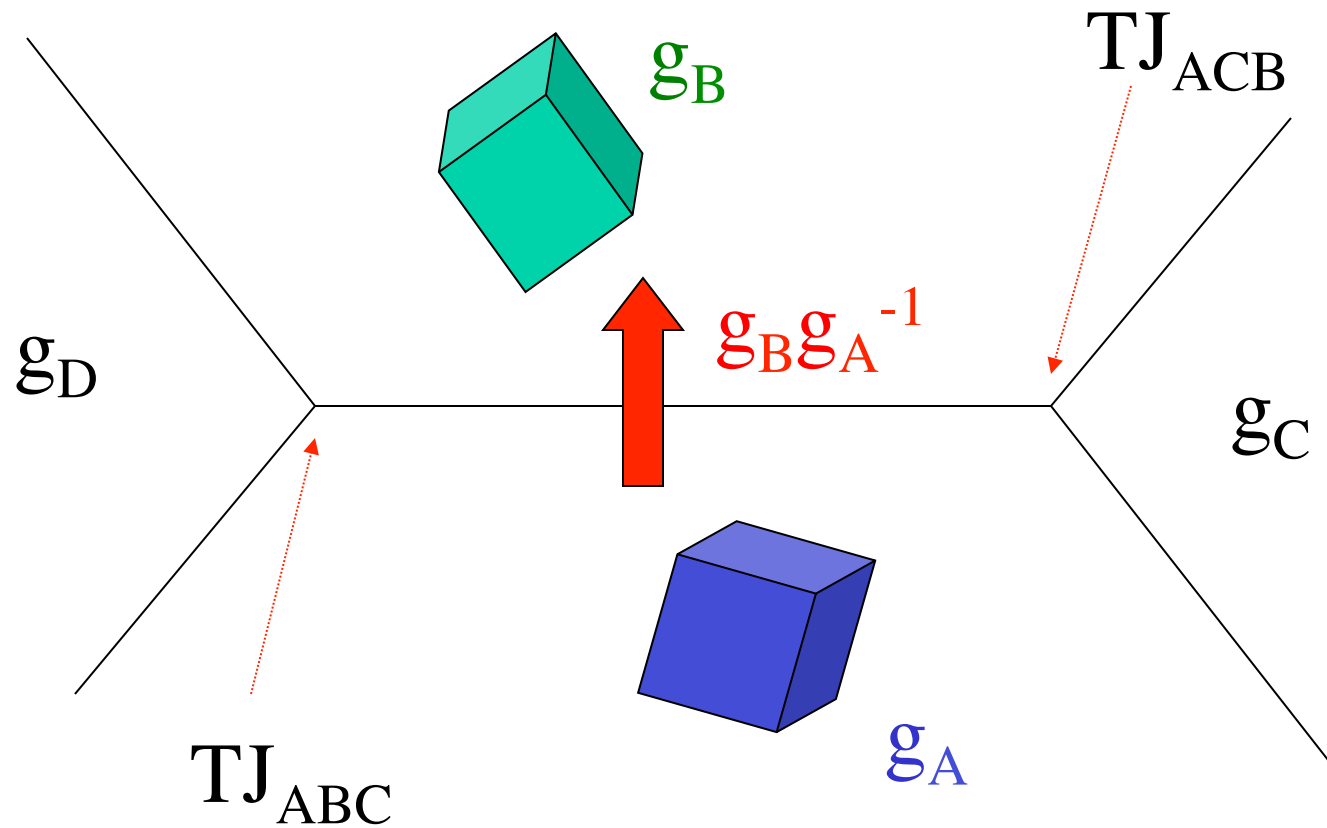

Switching Symmetry

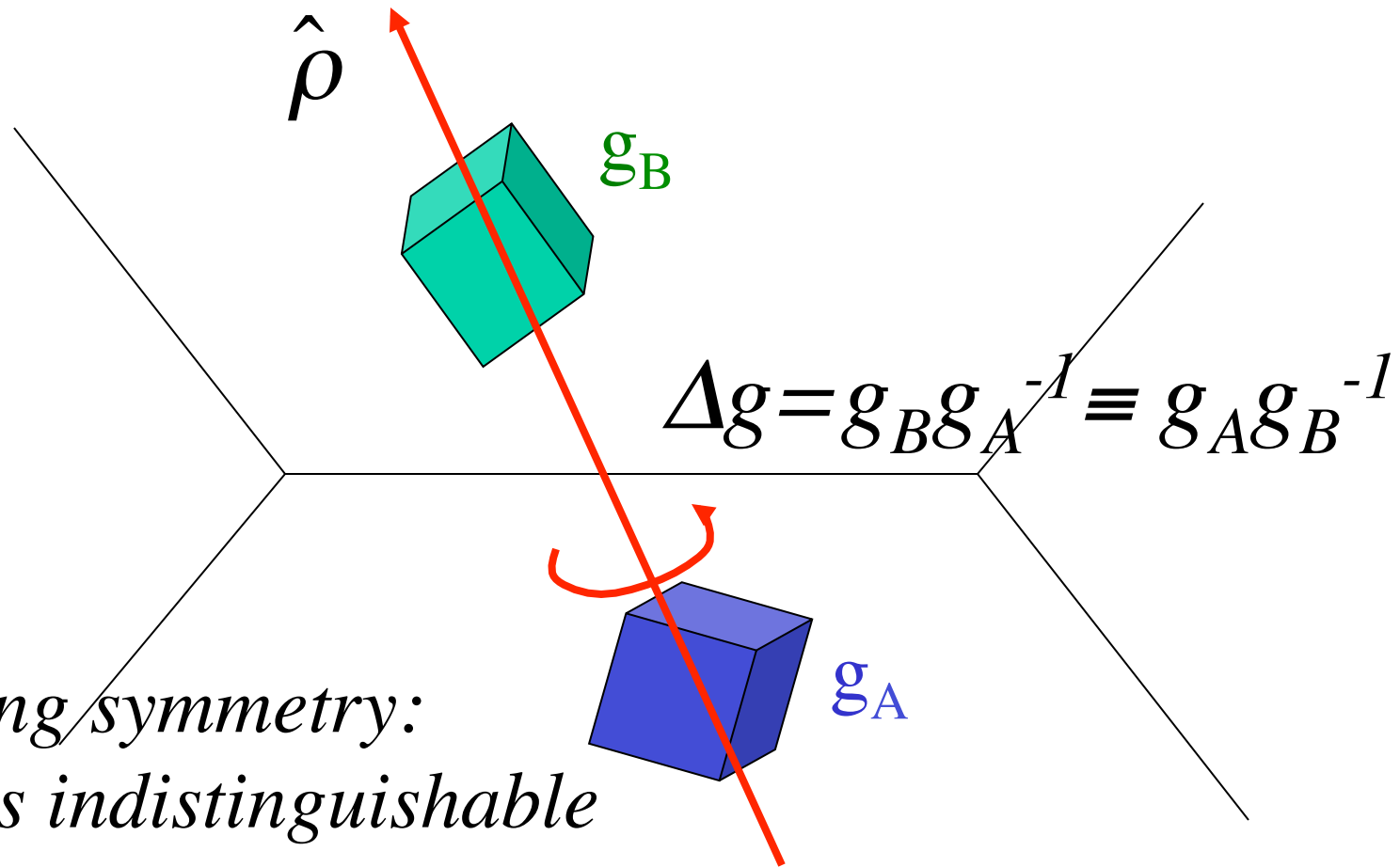

*Switching symmetry:
 A to B is indistinguishable
 from B to A because there is no difference in grain
 boundary structure*

Representations of Misorientation

- What is different from Texture Components?
- Miller indices not useful (except for describing the misorientation axis).
- Euler angles can be used but untypical.
- Reference frame is usually the crystal lattice (in one grain), *not* the sample frame.
- Application of symmetry is different (no sample symmetry!)

Grain Boundaries vs. Texture

- Why use the crystal lattice as a frame? Grain boundary structure is closely related to the *rotation axis*, i.e. the common crystallographic axis between the two grains.
- The crystal symmetry applies to both sides of the grain boundary; in order to put the misorientation into the *fundamental zone* (or *asymmetric unit*) two sets of 24 operators (for *cubic* symmetry) with the *switching symmetry* must be used. However only one set of 24 symmetry operators are needed to find the *minimum rotation angle*.

Disorientation

- Thanks to the cubic crystal symmetry, no two cubic lattices can be different by more than $\sim 62.8^\circ$ (see papers by Mackenzie).
- Combining two orientations can lead to a rotation angle as high as 180° : applying crystal symmetry operators decreases the required rotation angle.
- Disorientation:= (is defined as) the minimum rotation angle between two lattices with the misorientation axis located in the Standard Stereographic Triangle. Alternatively, the *disorientation* is the misorientation described in a particular *fundamental zone*.

Grain Boundary Representation

- Axis-angle representation: axis is the common crystal axis (but it is also possible to describe the axis in the sample frame); angle is the rotation angle, θ .
- 3x3 Rotation matrix, $\Delta g = g_B g_A^T$.
- Rodrigues vector: 3 component vector whose direction is the axis direction and whose length = $\tan(\theta / 2)$.

MD for Annealed Copper

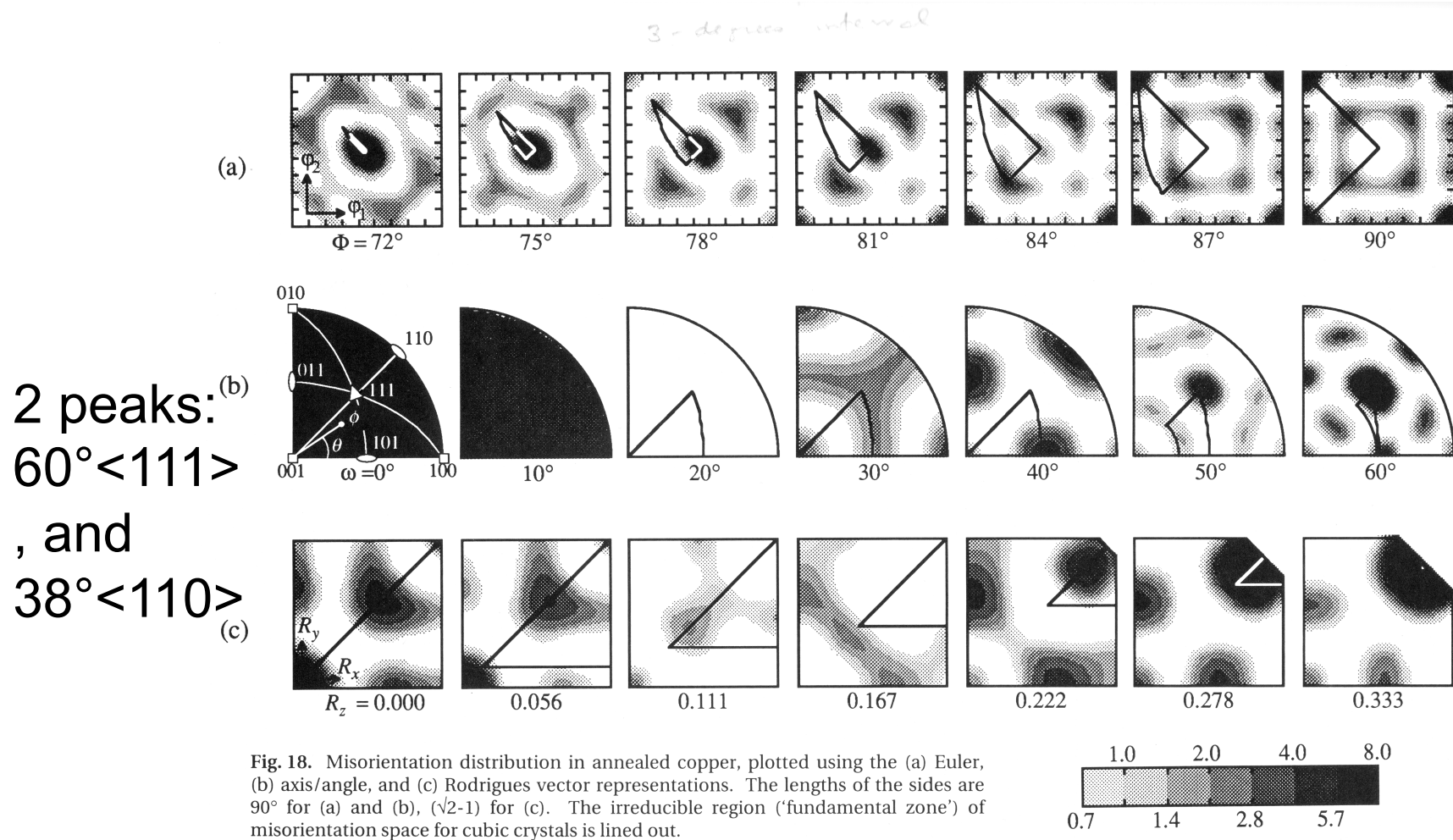

Fig. 18. Misorientation distribution in annealed copper, plotted using the (a) Euler, (b) axis/angle, and (c) Rodrigues vector representations. The lengths of the sides are 90° for (a) and (b), $(\sqrt{2}-1)$ for (c). The irreducible region ('fundamental zone') of misorientation space for cubic crystals is lined out.

Misorientation Distributions

- The concept of a *Misorientation Distribution* (*MD*, *MODF* or *MDF*) is analogous to an *Orientation Distribution* (*OD* or *ODF*).
- *Relative frequency* in the space used to parameterize misorientation, e.g. 3 components of *Rodrigues vector*, $f(R_1, R_2, R_3)$, or 3 *Euler angles* $f(\phi_1, \Phi, \phi_2)$ or axis-angle $f(\theta, \mathbf{n})$.
- Probability density (but normalized to units of Multiples of a Uniform Density) of finding a given misorientation in a certain range of misorientation, $d\Delta g$ (specified by all 3 parameters), is given by $f(d\Delta g)$.
- As before, when the word “function” is included in a name, this implies that a continuous mathematical function is available, such as obtained from a series expansion (with generalized spherical harmonics).

Area Fractions

- Grain Boundaries are *planar defects* therefore we should look for a distribution of *area* (or area per unit volume, S_V).
- Later we will define the *Grain Boundary Character Distribution* (GBCD) as the relative frequency of boundaries of a given crystallographic type.
- Fraction of area within a certain region of misorientation space, $\Delta\Omega$, is given by the MDF, f , where Ω_0 is the complete space:

$$\frac{\Delta A}{A} = \frac{\int_{\Delta\Omega} f(\Delta g) d\Delta g}{\int_{\Omega_0} f(\Delta g) d\Delta g}$$

Normalization of MDF

- If boundaries are randomly distributed then MDF has the same value everywhere, i.e. 1 (since a normalization is required).
- Normalize by integrating over the space of the 3 parameters (exactly as for ODF, except that the range of the parameters is different, in general). Thus the MDF is *not* a true probability density function in the statistical sense.
- If Euler angles used, the same equation applies (but one must adjust the normalization constant for the size of the space that is actually used):

$$\frac{1}{8\pi^2} \iiint f(\varphi_1, \Phi, \varphi_2) \sin \Phi d\varphi_1 d\Phi d\varphi_2 = 1$$

Estimation of MDF from ODF

- The EBSD softwares often refer to a “texture-based MDF”.
- One can always estimate the misorientations present in a material based on the texture. If grains are inserted at random, then the probability of finding a given boundary/misorientation type is the sum of all the possible combinations of orientations that give rise to that misorientation.
- Therefore one can estimate the MDF, based on an assumption of randomly placed orientations, drawn from the ODF, thus:

$$MD(\Delta g) = \frac{1}{\int d\Delta g} \int \int \frac{f(g)f(g')dg dg'}{\left(\int dg\right)^2}, \quad \Delta g = gg'^{-1}$$

- This texture-derived estimate is exactly the texture-based MDF mentioned above. It can be used to normalize the MDF obtained by characterizing grain boundaries in an EBSD map.

Differences in Orientation

- Preparation for the math of misorientations: the difference in orientation between two grains is a rotation just as is the rotation that describes a texture component.
- Careful! The application of symmetry is different from orientations because crystal symmetry applies to both sides of the relationship (but not sample symmetry),
- Convention: we use different methods (Rodrigues vectors, or axis-angle) to describe g.b. misorientation than for texture (but we could use Euler angles for everything, for example).

Example: Twin Boundary in fcc

The energy of the coherent twin GB is exceptionally low because of the perfect atomic fit between the two surfaces.

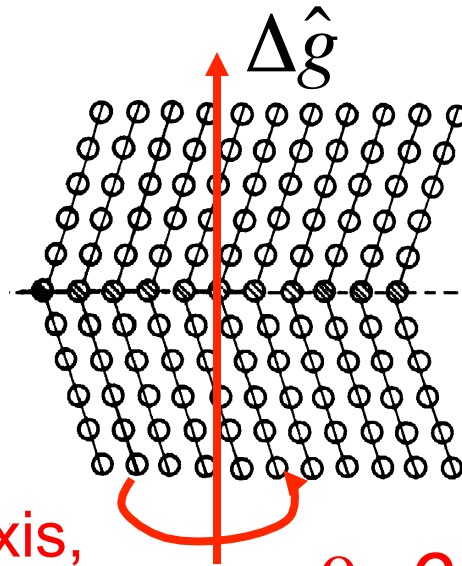

$\langle 111 \rangle$ rotation axis,
common to both crystals

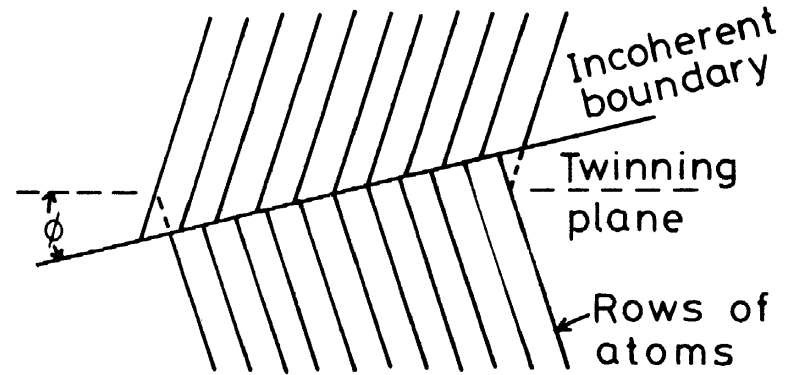

(b)

CSL: $\Sigma 3$

Axis/Angle: $60^\circ \langle 111 \rangle$

Rodrigues: $[1/3, 1/3, 1/3]$

Quaternion: $[1/2, 1/2, 1/2, 1/2]$

MATRIX REPRESENTATION:

$\begin{bmatrix} 0.667 & 0.667 & -0.667 \\ -0.333 & 0.667 & 0.667 \\ 0.333 & -0.333 & 0.667 \end{bmatrix}$

$\begin{bmatrix} -0.333 & 0.667 & 0.667 \\ 0.333 & -0.333 & 0.667 \end{bmatrix}$

$\begin{bmatrix} 0.333 & -0.333 & 0.667 \end{bmatrix}$

(c)

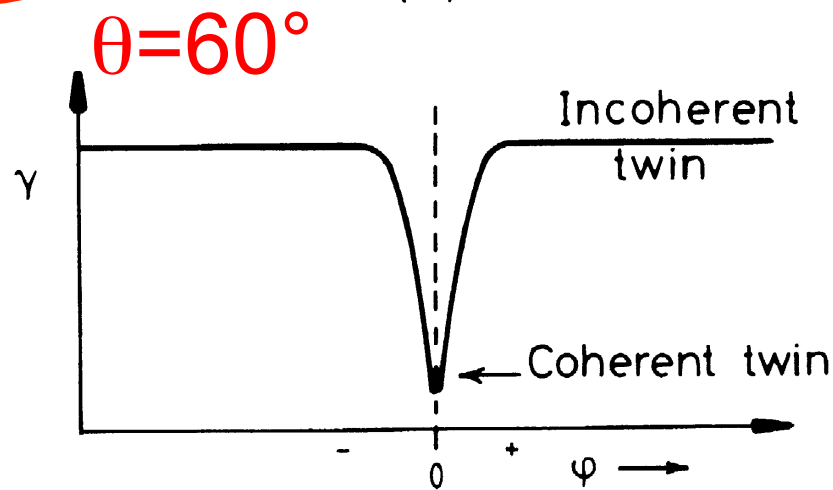

Porter & Easterling fig. 3.12/p123

There is also an minimum g.b. energy "twin" in bcc metals, which is $60^\circ \langle 111 \rangle$ with a $\{112\}$ normal

Coherent vs. Incoherent Twin

- The word “coherent” refers to coherency or matching of atoms across an interface. When two close-packed 111 planes (in fcc materials) are placed in contact, there are two positions (relative rotations, with in-plane adjustments) that provide exact atom matching. One results in no boundary at all, and the other has a 60° misorientation about the interface normal. This latter is the “coherent twin”.
- Any interface with the same misorientation but a different normal than 111 is an incoherent twin boundary because the atoms do not fit together exactly.
- Fcc metals with medium to low stacking energy commonly exhibit high fractions of coherent twin boundaries or “annealing twins”.
- The word “twin” is also used for deformation twins. In the most general sense it refers to pairs of orientations related by a mirror; centro-symmetry allows a proper rotation to accomplish the same relationship. We return to this topic when we discuss Coincident Site Lattice (CSL) misorientations.
- This will be addressed in more detail elsewhere.
- For atomistic calculations of g.b. energy, see: Olmsted, D. L., S. M. Foiles *et al.* (2009), "Survey of computed grain boundary properties in face-centered cubic metals: I. Grain boundary energy." *Acta materialia* **57**: 3694-3703.

Grain Boundary Representation

- Axis-angle representation: axis is the common crystal axis (but could also describe the axis in the sample frame); angle is the rotation angle, θ .
- 3x3 Rotation matrix, $\Delta g = g_B g_A^{-1}$.
- Rodrigues vector: 3 component vector whose direction is the *misorientation axis* direction and whose length is equal to the tangent of 1/2 of the rotation angle, θ :

$$\mathbf{R} = \tan(\theta/2)\mathbf{v},$$

\mathbf{v} is a unit vector representing the rotation axis.

Misorientation + Symmetry

- The crystal symmetry pre-multiplies the orientation matrix
- $\Delta g =$
 $(O_c g_B)(O_c g_A)^{-1}$
 $= O_c g_B g_A^{-1} O_c^{-1} = O_c g_B g_A^{-1} O_c$
- Note the presence of symmetry operators pre- & post-multiplying the misorientation; no inverse is needed for a symmetry operator (member of a finite group).

Symmetry: how many equivalent representations of misorientation?

- Axis transformations:
24 independent operators (for cubic) present on either side of the misorientation. Two equivalents from switching symmetry, i.e. the fact that there is no (physical) difference between passing from grain A to grain B, versus passing from grain B to grain A.
- Number of equivalents = $24 \times 24 \times 2 = 1152$.

Rodrigues vector, contd.

- Many of the boundary types that correspond to a high fraction of *coincident lattice sites* (i.e. low sigma values in the CSL model) occur on the edges of the Rodrigues space.
- CSL boundaries have simple values, i.e. components are reciprocals of integers:
e.g. twin in fcc = $(1/3, 1/3, 1/3) \equiv 60^\circ \langle 111 \rangle \equiv \Sigma 3$.
The “sigma number” is the reciprocal of the fraction of common (coincident) sites between the lattices of the two grains.
- RF space is also useful for texture representation.
- CSL theory of grain boundaries will be explained in a later lecture: for now, think of a CSL type as a particular (mathematically singular) misorientation for which good atomic fit may be expected (and therefore special properties). A list of values for CSL types up to $\Sigma=29$ is provided in the supplemental slides.
- How does one compute how near a GB is to a CSL boundary type? The answer is to first make sure that both are in the same FZ, then compute the misorientation between them, in exactly the same way as for a pair of orientations. This is described in more detail in the lecture on CSLs.

Examples of symmetry operators in various parameterizations

- Diad on z
or C_{2z} , or
 L_{001}^2 : $\begin{pmatrix} -1 & 0 & 0 \\ 0 & -1 & 0 \\ 0 & 0 & 1 \end{pmatrix} \equiv \tan 90^\circ(0,0,1) = (0,0,\infty)$
- Triad about
[111], or
 120° - $\langle 111 \rangle$,
or, L_{111}^3 : $\begin{pmatrix} 0 & 1 & 0 \\ 0 & 0 & 1 \\ 1 & 0 & 0 \end{pmatrix} \equiv \tan 60^\circ \frac{(1,1,1)}{\sqrt{3}} = (1,1,1)$

Note how infinity is a common value in the Rodrigues vectors that describe 180° rotations (2-fold diad axes). This makes Rodrigues vectors awkward to use from a numerical perspective and is one reason why (unit) quaternions are used.

Cubic Crystal Symmetry Operators

| Symmetry Operator | | Rodrigues Vector | Unit Quaternion |
|---------------------------------|-------------|--|---|
| 2-fold on $\langle 100 \rangle$ | L_{100}^2 | $\infty(1,0,0)$ $\infty(0,1,0)$ $\infty(0,0,1)$ | $\pm(1,0,0,0),$ $\pm(0,1,0,0)$ $\pm(0,0,1,0)$ |
| 4-fold on $\langle 100 \rangle$ | L_{100}^4 | $\pm(1,0,0)$ $\pm(0,1,0)$ $\pm(0,0,1)$ | $\pm 1/\sqrt{2}(\pm 1,0,0,1),$ $\pm 1/\sqrt{2}(0, \pm 1,0,1)$ $\pm 1/\sqrt{2}(0,0, \pm 1,1)$ |
| 2-fold on $\langle 110 \rangle$ | L_{110}^2 | $\infty(1, \pm 1,0)$ $\infty(1,0, \pm 1)$ $\infty(0,1, \pm 1)$ | $\pm 1/\sqrt{2}(\pm 1,1,0,0),$ $\pm 1/\sqrt{2}(0,1, \pm 1,0)$ $\pm 1/\sqrt{2}(\pm 1,0,1,0)$ |
| 3-fold on $\langle 111 \rangle$ | L_{111}^3 | $\pm(1,1,1)$ $\pm(1,-1,1)$ $\pm(1,1,-1)$ $\pm(-1,-1,1)$ | $\pm 1/2(\pm 1,1,1,1),$ $\pm 1/2(1, -1, 1,1),$ $\pm 1/2(1,1,-1,1),$ $\pm 1/2(-1,-1, 1,1)$ $\pm 1/2(-1,1,-1,1),$ $\pm 1/2(1,-1,-1,1)$ $\pm 1/2(-1,-1,-1,1))$ |

The numerical values of these symmetry operators can be found at:
http://neon.materials.cmu.edu/texture_subroutines: quat.cubic.symm etc.

Symmetry in Rodrigues space

- Demonstration of symmetry elements as planes
- Illustration of action of a symmetry element -90° about $[100]$ which is the Rodrigues vector $[-1,0,0]$.
- Order of application of elements to active rotations.
- In this case, it is useful to demonstrate that any vector on the plane $\rho_1 = \sqrt{2}-1$ is mapped onto the plane $\rho_1 = -1(\sqrt{2}-1)$.

Example: $90^\circ \langle 100 \rangle$

- Consider the vector $[\sqrt{2}-1, \rho_2, \rho_3]$ acted on by the operator $[-1, 0, 0]$, i.e. -90° about $[100]$:

$$\rho_C = (\rho_A, \rho_B) = \{\rho_A + \rho_B - \rho_A \times \rho_B\} / \{1 - \rho_A \cdot \rho_B\}$$

$$\begin{aligned} \rho_C &= \frac{[\sqrt{2}-1, \rho_2, \rho_3] + [-1, 0, 0] - [0, -\rho_3, \rho_2]}{1 - \{-1(\sqrt{2}-1)\}} = \frac{[\sqrt{2}-2, \rho_2 + \rho_3, \rho_3 - \rho_2]}{1 - \{1 - \sqrt{2}\}} \\ &= \frac{[\sqrt{2}-2, \rho_2 + \rho_3, \rho_3 - \rho_2]}{\sqrt{2}} \\ &= \left[-(\sqrt{2}-1), \frac{\rho_3 + \rho_2}{2 - \sqrt{2}}, \frac{\rho_2 - \rho_3}{2 - \sqrt{2}} \right] \end{aligned}$$

Cross product term

Scalar product term

Any point *outside* the plane defined by $R_1 = (\sqrt{2}-1)$ will be equivalent to a point *inside the plane* $R_1 = -(\sqrt{2}-1)$. Thus this pair of planes define edges of the fundamental zone.

Action of 90° about $[100]$

Inspection of the result shows that any point on the plane $\rho_1 = \sqrt{2}-1$ is mapped onto a new, symmetry-related point lying on the plane $\rho_1 = -1*(\sqrt{2}-1)$, regardless of the values of the other two parameters of the Rodrigues vector.

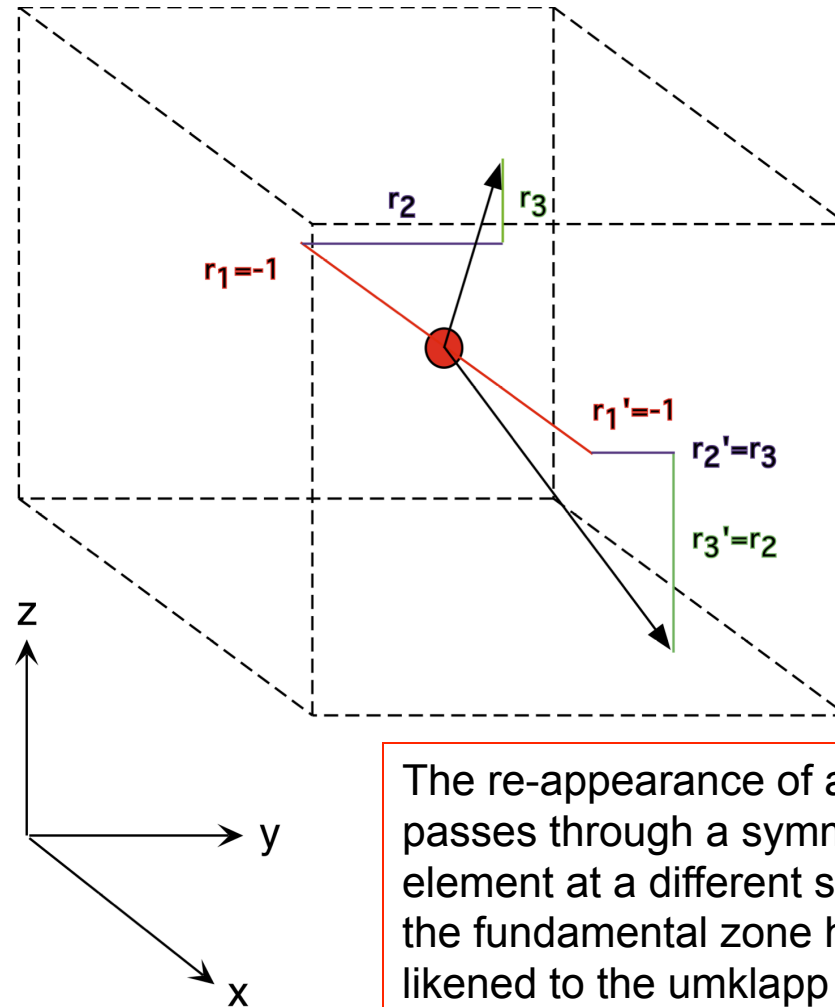

Symmetry planes in RF space

- The effect of *any* symmetry operator in Rodrigues space is to insert a dividing plane in the space. If \mathbf{R} ($= \tan(\theta/2)\mathbf{v}$) is the vector that represents the symmetry operator (\mathbf{v} is a unit vector), then the dividing plane is $\mathbf{y} + \tan(\pm\theta/4)\mathbf{v}$, where \mathbf{y} is an arbitrary vector perpendicular to \mathbf{v} .
- This arises from the geometrical properties of the space (extra credit: prove this property of the Rodrigues-Frank vector).

Fundamental Zone, FZ

- By setting limits on all the components (and confining the axis associated with an RF vector to the SST) we have implicitly defined a *Fundamental Zone*.
- The *Fundamental Zone* is simply the set of (mis-)orientations for which there is one unique representation for any possible misorientation. This unique representation is sometimes termed the *disorientation*.
- Note: the standard 90x90x90 region in Euler space for *orientations* contains 3 copies of the FZ for cubic-orthorhombic symmetry. The 90x90x90 region in Euler space for *misorientations* contains 48 copies of the FZ for cubic-cubic symmetry. Just as with orientations, so for misorientations, we can apply group theory to compute the size of the (mis-)orientation space needed for a FZ.

Size, Shape of the Fundamental Zone

- We can use some basic information about crystal symmetry to set limits on the size of the FZ.
- Clearly in cubic crystals we cannot rotate by more than 45° about a $\langle 100 \rangle$ axis before we encounter equivalent rotations by going in the opposite direction; this sets the limit of
$$R_1 = \tan(22.5^\circ) = \sqrt{2} - 1.$$
- This defines a *plane* perpendicular to the R_1 axis.

Size, Shape of the Fundamental Zone

- Similarly, we cannot rotate by more than 60° about $\langle 111 \rangle$, which sets a limit of $(1/3, 1/3, 1/3)$ along the $\langle 111 \rangle$ axis, or $\sqrt{\{R_1^2 + R_2^2 + R_3^2\}} = \tan(30^\circ) = 1/\sqrt{3}$. Note that this is the limit on the length of the Rodrigues vector // 111 . In general, the limit is expressed as the equation of a plane, $R_1 + R_2 + R_3 = 1$.
- Symmetry operators can be defined in Rodrigues space, just as for matrices or Euler angles. However, we typically use unit quaternions for operations with rotations because some of the symmetry operators, when expressed as Rodrigues vectors, contain infinity as a coefficient, which is highly inconvenient numerically!
- The FZ for grain boundaries in cubic materials has the shape of a truncated pyramid.

Delimiting planes

- For the combination of $O(222)$ for orthorhombic sample symmetry and $O(432)$ for cubic crystal symmetry, the limits on the Rodrigues parameters are given by the planes that delimit the fundamental zone.
- These include (for cubic crystal symmetry with $O(432)$):
 - six octagonal facets orthogonal to the $\langle 100 \rangle$ directions, at a distance of $\tan(\pi/8)$ ($=\sqrt{2}-1$) from the origin, and
 - eight triangular facets orthogonal to the $\langle 111 \rangle$ directions at a distance of $\tan(\pi/6)$ ($=\sqrt{3}-1$) from the origin.
- The sample symmetry operators appear as planes that intersect the origin, with normals parallel to the associated rotation axis. A slightly odd feature of RF-space (not well explained in the books) is that each 2-fold operator (diad) excludes $\frac{1}{2}$ the space. If one were to literally divide the space by two perpendicular to each direction, then one would be left with only an octant, which would contain only $\frac{1}{8}$ the volume of the original. However, one has to recall that combining any pair of diads (from $O(222)$) leads the same result and adding a third diad makes no difference. Strictly speaking, one should keep the all-positive octant and the all-negative octant. It is convenient for representation to keep two adjacent octants, as shown by Neumann (next slide). This “trick” has the effect of making the y-axis look different from x and z, but this is a visual convenience.

Symmetry planes in RF space

4-fold axis on $\langle 100 \rangle$

3-fold axis on $\langle 111 \rangle$

Cubic crystal symmetry,
no sample symmetry

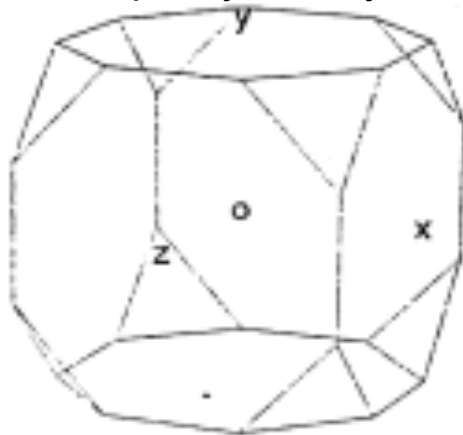

a)

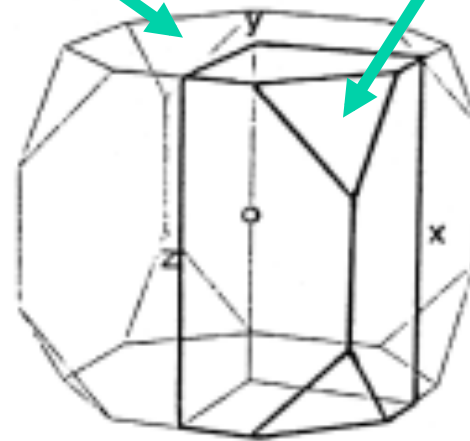

b)

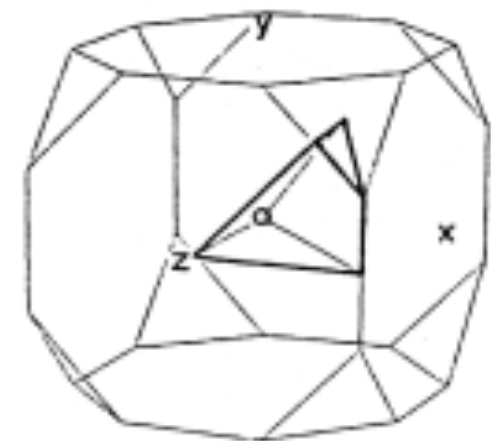

c)

Cubic-orthorhombic

Cubic-cubic symmetry

Neumann, P. (1991). "Representation of orientations of symmetrical objects by Rodrigues vectors." *Textures and Microstructures* 14-18: 53-58

Truncated pyramid for cubic-cubic misorientations

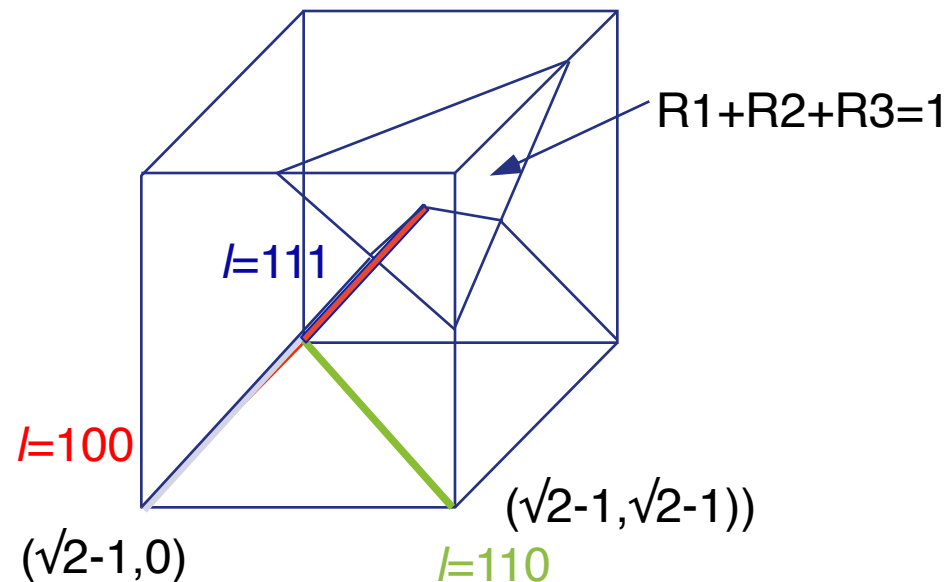

The fundamental zone for grain boundaries between cubic crystals is a truncated pyramid.

Range of Values of RF vector components for grain boundaries in cubic materials

- Q. If we use Rodrigues vectors, what range of values do we need to represent grain boundaries?
- A. Since we are working with a rotation axis that is based on a *crystal direction* then it is logical to confine the axis to the *standard stereographic triangle (SST)*.

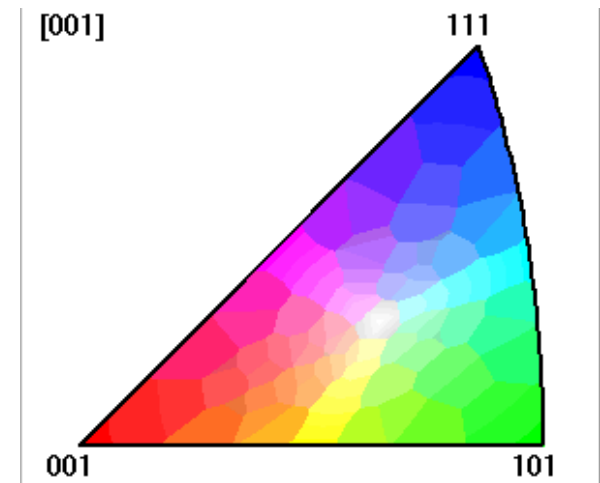

Colored triangle copied from TSL™ software

Shape of RF Space for cubic-cubic

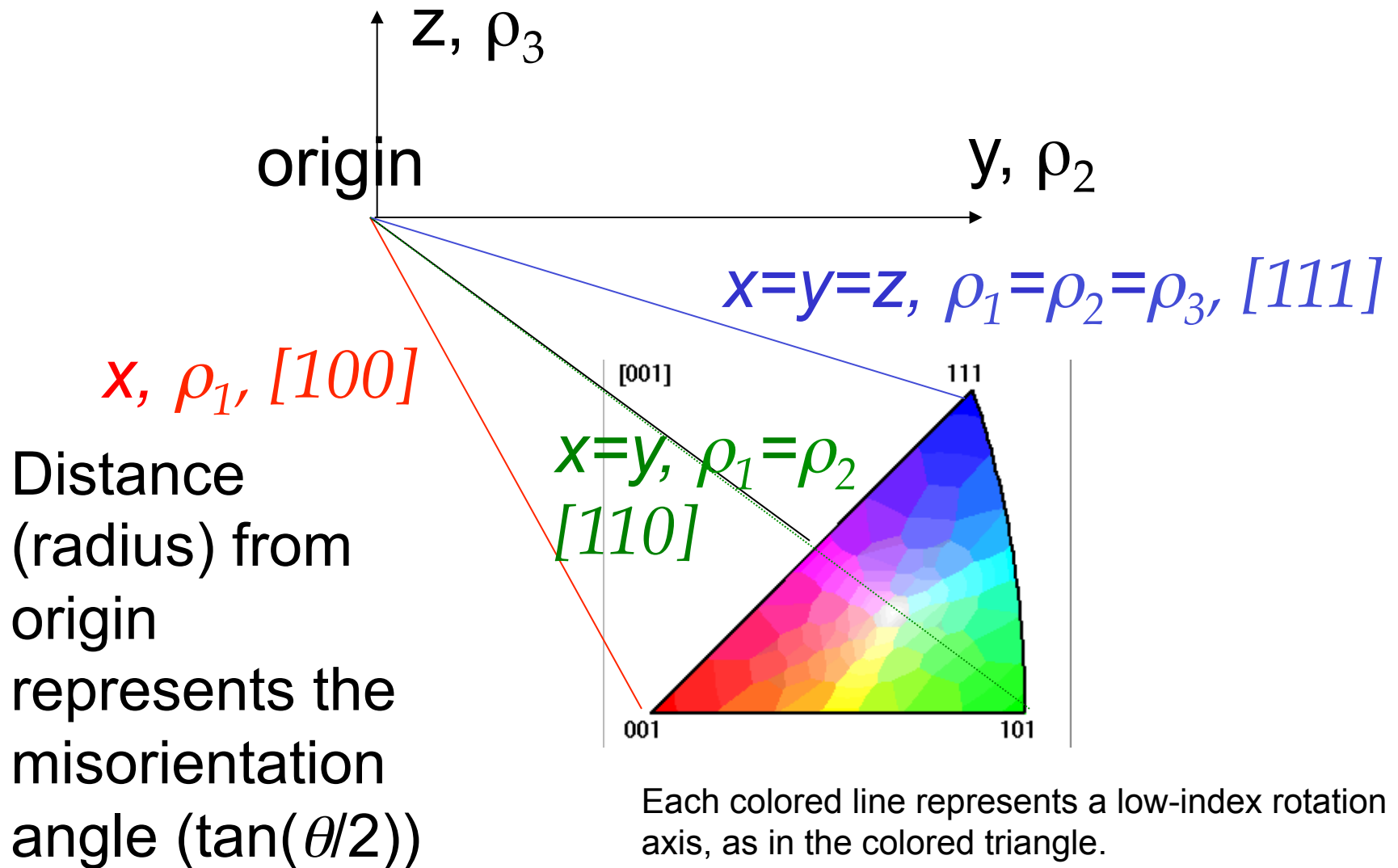

Range of RF vector components

- ρ_1 corresponds to the component $//[100]$;
 ρ_2 corresponds to the component $//[010]$;
 ρ_3 corresponds to the component $//[001]$;
- $\rho_1 > \rho_2 > \rho_3 > 0$
- $0 \leq \rho_1 \leq (\sqrt{2}-1)$
- $\rho_2 \leq \rho_1$
- $\rho_3 \leq \rho_2$
- $\rho_1 + \rho_2 + \rho_3 \leq 1$

45° rotation about $\langle 100 \rangle$

60° rotation about $\langle 111 \rangle$

Alternate Notation: $(R_1 R_2 R_3)$

- R_1 corresponds to the component $//[100]$;
 R_2 corresponds to the component $//[010]$;
 R_3 corresponds to the component $//[001]$;
- $R_1 > R_2 > R_3 > 0$
- $0 \leq R_1 \leq (\sqrt{2}-1)$
- $R_2 \leq R_1$
- $R_3 \leq R_2$
- $R_1 + R_2 + R_3 \leq 1$

Sections through RF-space

- For graphical representation, the R-F space is typically sectioned parallel to the 100-110 plane.
- Each triangular section has $R_3 = \text{constant}$.
- Most of the special CSL relationships lie on the 100, 110, 111 lines.

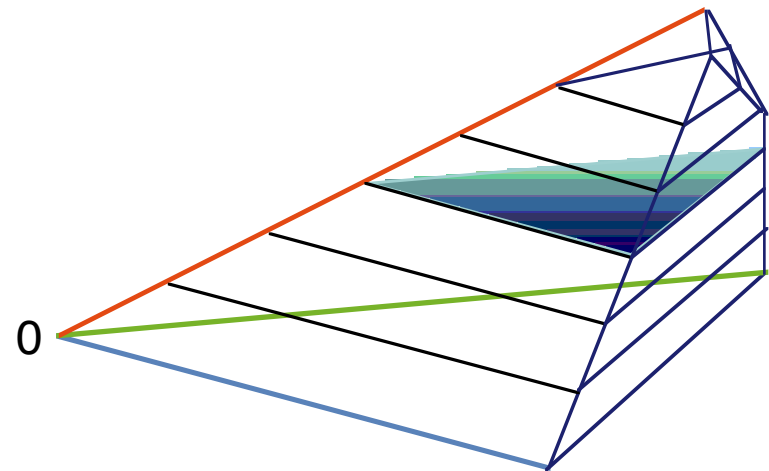
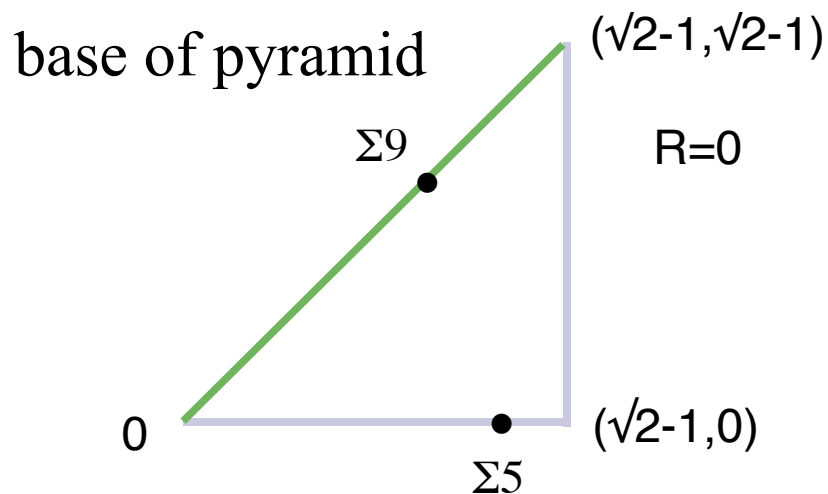

RF-space

Exercise: show that the largest possible misorientation angle corresponds to the point marked by \circ . Based on the geometry of the fundamental zone, calculate the angle (as an inverse tangent). Hint: the answer is in Frank's 1988 paper on Rodrigues vectors.

$$\rho_1 + \rho_2 + \rho_3 \leq 1$$

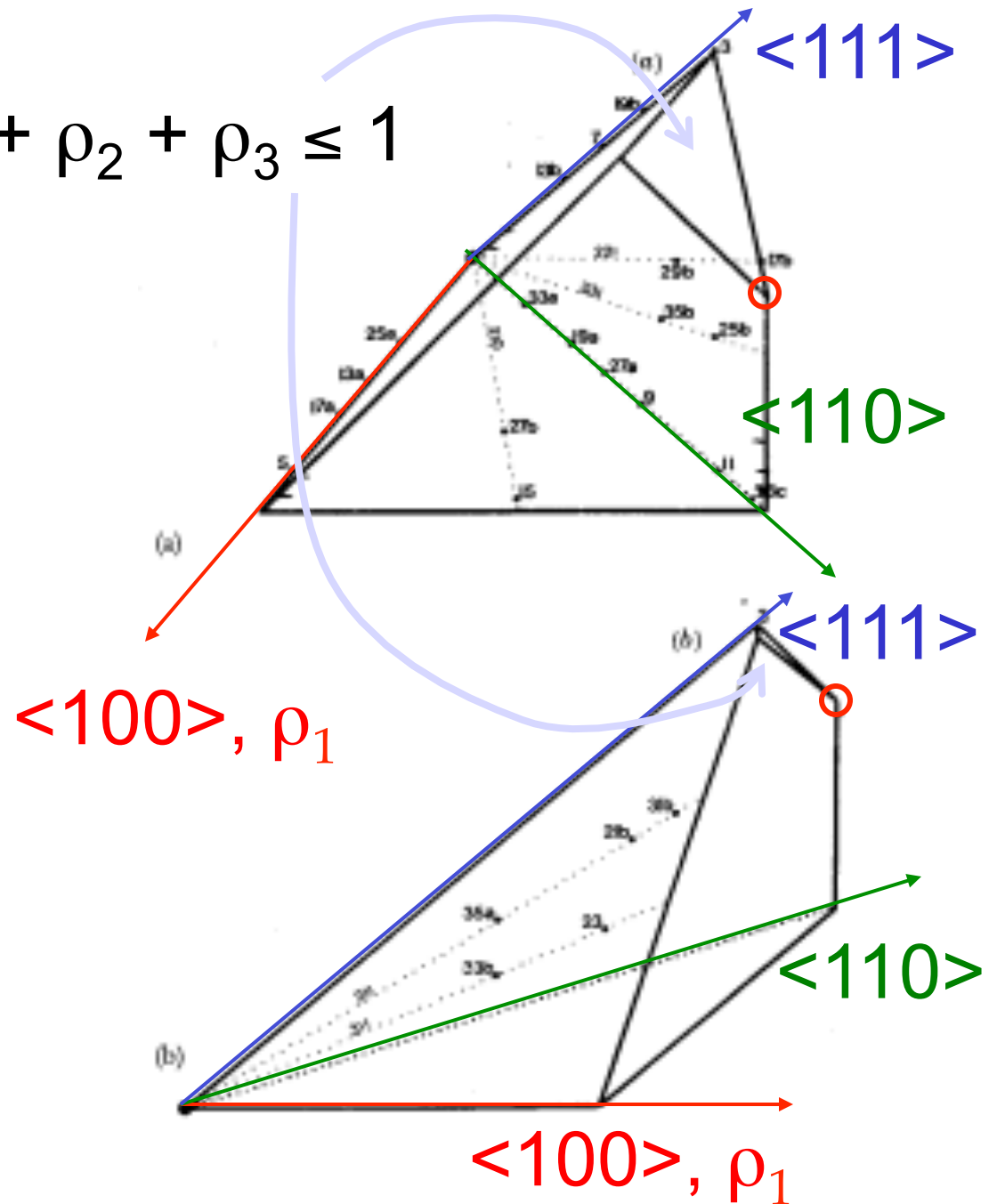

[Randle]

Density of points in RF space

- The variation in the volume element with magnitude of the RF vector (i.e. with misorientation angle) is such that the density of points decreases slowly with distance from the origin.
- For a random distribution, low angle boundaries are rare, so in a one-parameter distribution based on misorientation angle, the frequency increases rapidly with angle up to the maximum at 45° . Think of integrating the volume in successive spherical layers (layers of an onion). The outer layers have larger volumes than the inner layers.
- Mackenzie, J. K. (1958). "Second paper on statistics associated with the random orientation of cubes." *Biometrika* **45**: 229-240.

Mackenzie Distribution for cubic-cubic

- Frequency distribution with respect to disorientation angle for randomly distributed grain boundaries.
- This result can be easily obtained by generating sets of random orientations, and applying crystal symmetry to find the minimum rotation angle for each set, then binning, normalizing (to unit area) and plotting.
- Note: this is a true *probability density function*

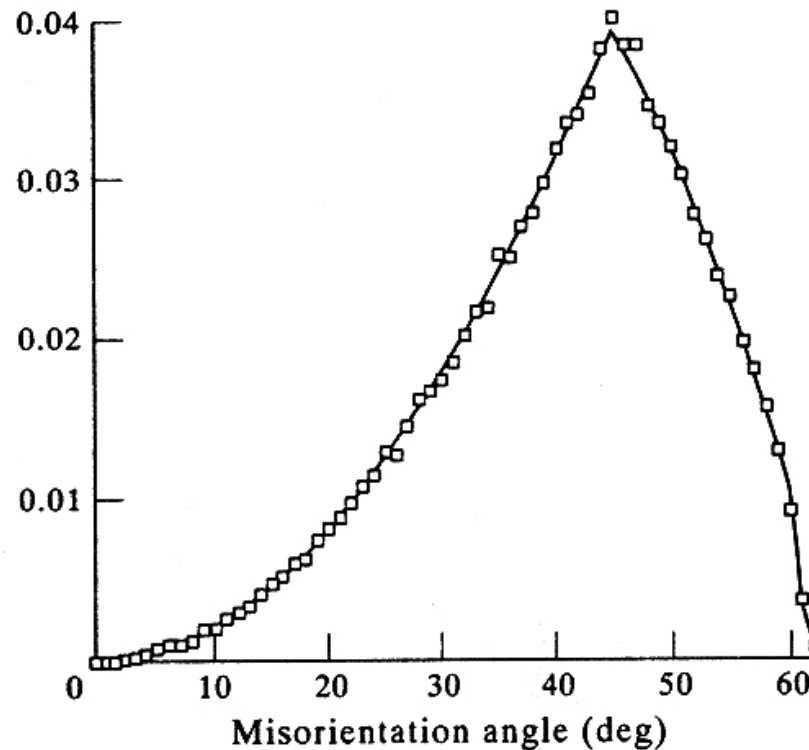

Fig. 1. Theoretical (line) and calculated (squares) misorientation angle distributions.

Morawiec A, Szpunar JA, Hinz DC (1993) *Acta metall. mater.* **41** 2825.

The peak at 45° is associated with the 45° rotation limit on the $\langle 100 \rangle$ axis - again, think of integrating over a spherical shell associated with each value of the misorientation angle.

Experimental Example

- Note the bias to certain misorientation axes within the SST, i.e. a high density of points close to $\langle 101 \rangle$ and $\langle 111 \rangle$.

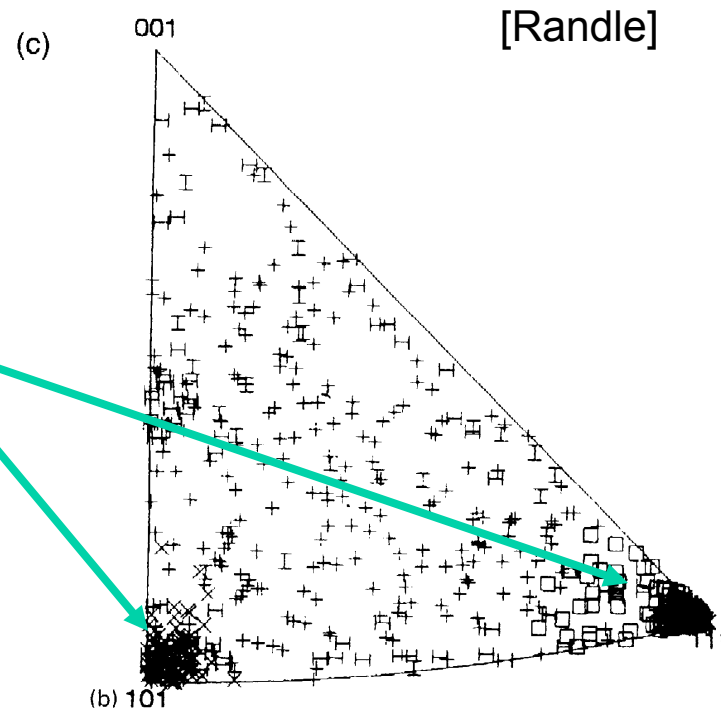

Figure 9.12 Distribution of disorientation axes for cubic crystals in a single unit triangle of the stereographic projection. (a) probability density plot; (b) percentage of disorientation axes lying in the various regions (Mackenzie, 1964); (c) use of the Mackenzie triangle to display disorientation axes. Different symbols are used to denote several different CSL types (Randle and Caul, 1996).

Experimental Distributions by Angle

<100> fiber texture, columnar casting

Random, equi-axed casting

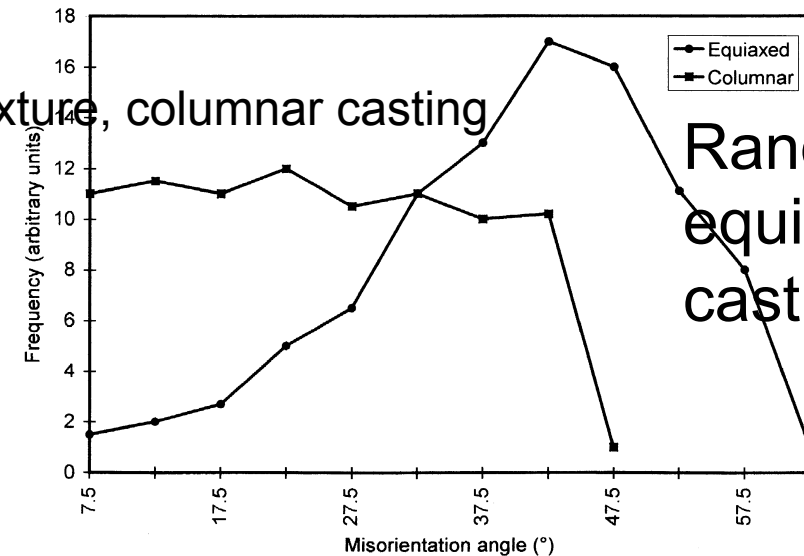

Figure 9.13 Disorientation angle distributions for two types of grains, equiaxed and columnar, in nickel (Adapted from West and Adams, 1997).

Fiber textures with a uniform distribution about the fiber axis give rise to uniform densities in the MD because they are one-parameter distributions. The cut-off angle depends on symmetry: thus 45° for 100 and 60° for 111.

Random:

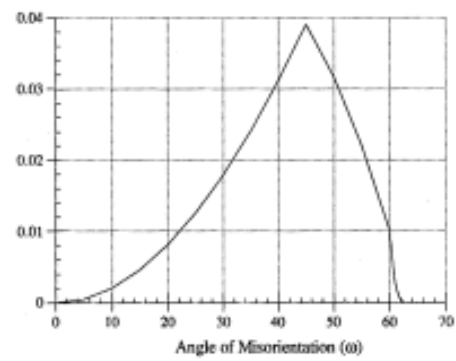

Fig. 19. The distribution function of the rotation angle α for a random set of cubic crystals [MACKENZIE 1958].

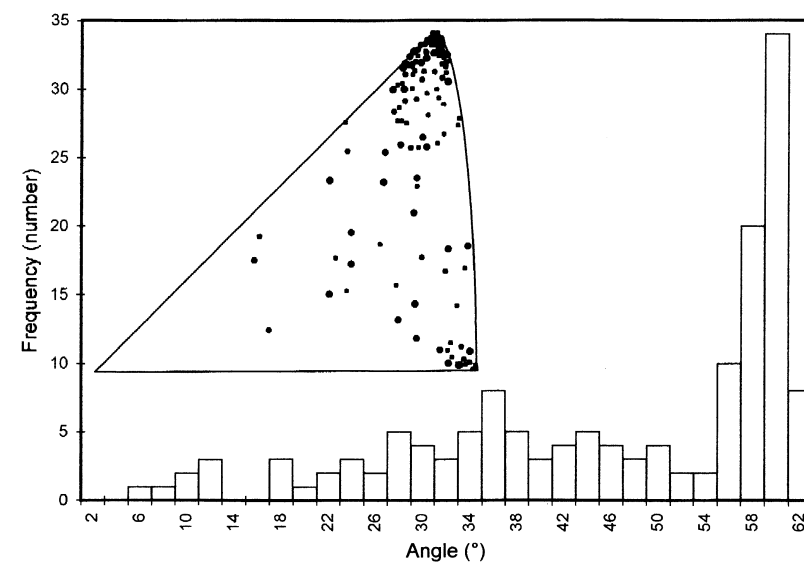

Figure 9.14 Misorientation distribution, comprising both the angle and axis distribution, from stainless steel (Adapted from Gertsman and Tangri, 1991).

[Randle]

Choices for MDF Plots

- Euler angles: use subset of 90x90x90 region, starting at $\Phi=72^\circ$.
- Axis-angle plots, using SST (or 001-100-010 quadrant) and sections at constant misorientation angle.
- Rodrigues vectors, using either square sections, or triangular sections through the fundamental zone.

MDF for Annealed Copper

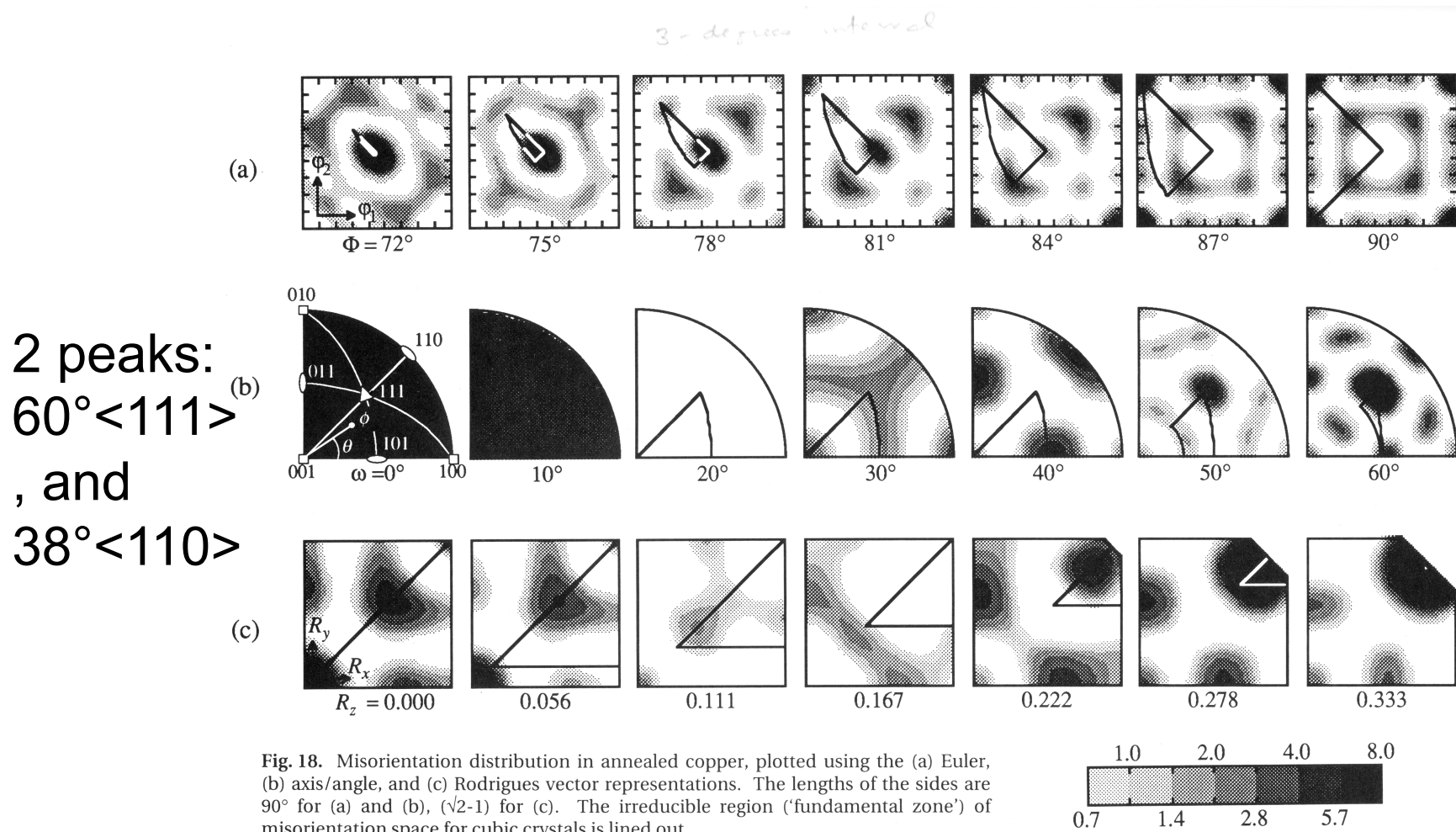

Fig. 18. Misorientation distribution in annealed copper, plotted using the (a) Euler, (b) axis/angle, and (c) Rodrigues vector representations. The lengths of the sides are 90° for (a) and (b), $(\sqrt{2}-1)$ for (c). The irreducible region ('fundamental zone') of misorientation space for cubic crystals is lined out.

Kocks, Ch.2

Summary

- Grain boundaries require 3 parameters to describe the lattice relationship because it is a rotation (misorientation).
- In addition to the misorientation, boundaries require an additional two parameters to describe the plane.
- Rodrigues vectors are useful for representing grain boundary crystallography; axis-angle and unit quaternions also useful.
Calculations are generally performed with unit quaternions.

Questions

- What is a grain boundary?
- What is misorientation, and how does it related to grain boundaries?
- How can we quantify or parameterize misorientation?
- What is the misorientation distribution?
- How do we apply symmetry to misorientations, and how does that affect the fundamental zone for misorientations?
- What are typical 1D and 3D representations of MDs?

Questions: 2

- What is a Rodrigues vector and how does it relate to an axis-angle description of a grain boundary misorientation?
- What is the relationship between misorientation-with-normal and the tilt-twist approach to describing grain boundaries?
- How do we mean by 5-parameter descriptions of grain boundaries?
- What are examples of symmetry operators described by Rodrigues vectors?
- How is symmetry revealed in Rodrigues-Frank space?
- What are the limits on the FZ in RF space for cubic-cubic misorientations?

References

- A. Sutton and R. Balluffi (1996), *Interfaces in Crystalline Materials*, Oxford.
- J. Howe (1997), *Interfaces in Materials*, Wiley.
- Morawiec, A. (2003), *Orientations and Rotations*, Berlin: Springer.
- V. Randle & O. Engler (2009). *Texture Analysis: Macrotecture, Microtexture & Orientation Mapping*. 2nd Ed. Amsterdam, Holland, CRC Press.
- Frank, F. (1988), "Orientation mapping." *Metallurgical Transactions* **19A**: 403-408.
- Neumann, P. (1991), "Representation of orientations of symmetrical objects by Rodrigues vectors", *Textures and Microstructures* **14-18**: 53-8
- Mackenzie, J. K. (1958), Second paper on statistics associated with the random orientation of cubes *Biometrika* **45** 229-40.
- Adam J. Schwartz and Mukul Kumar, *Electron Backscatter Diffraction in Materials Science*, 2nd Ed., Springer, 2009.
- Shoemake, K. (1985) Animating rotation with quaternion curves. In: *Siggraph'85*: Association for Computing Machinery (ACM)) pp 245-54.
- mtex - Quantitative Texture Analysis Software; Texture Analysis with MTEX - Free and Open Source Software Toolbox, F. Bachmann, R. Hielscher, H. Schaeben: *Solid State Phenomena* (2010) **160** 63-68

Supplemental Slides

Conversions for Axis

Matrix representation, a , to axis, $[uvw]=\mathbf{v}$:

$$\mathbf{v} = \frac{(a_{23} - a_{32}), (a_{31} - a_{13}), (a_{12} - a_{21})}{\sqrt{(a_{23} - a_{32})^2 + (a_{31} - a_{13})^2 + (a_{12} - a_{21})^2}}$$

Rodrigues
vector:

$$\mathbf{v} = \frac{R_1, R_2, R_3}{\sqrt{R_1^2 + R_2^2 + R_3^2}}$$

Quaternion:

$$\mathbf{v} = \frac{q_1, q_2, q_3}{\sqrt{q_1^2 + q_2^2 + q_3^2}}$$

N.B. the axis is assumed to be from an axis transformation

Maximum rotation: cubics

- The vertices of the triangular facets have coordinates $(\sqrt{2}-1, \sqrt{2}-1, 3-2\sqrt{2})$ (and their permutations), which lie at a distance $\sqrt{(23-16\sqrt{2})}$ from the origin. This is equivalent to a rotation angle of $62.7994\dots^\circ$, which represents the greatest possible rotation angle, either for a grain rotated from the reference configuration (i.e. orientation), or between two grains (i.e. disorientation).

How to Choose the Misorientation Angle: quaternions

- This algorithm is valid **only** for cubic-cubic misorientations and for obtaining *only* the angle (not the axis).
- Arrange $q_4 \geq q_3 \geq q_2 \geq q_1 \geq 0$.
Choose the maximum value of the fourth component, q_4' , from three variants as follows:
 - [i] (q_1, q_2, q_3, q_4)
 - [ii] $(q_1 - q_2, q_1 + q_2, q_3 - q_4, q_3 + q_4) / \sqrt{2}$
 - [iii] $(q_1 - q_2 + q_3 - q_4, q_1 + q_2 - q_3 - q_4, -q_1 + q_2 + q_3 - q_4, q_1 + q_2 + q_3 + q_4) / 2$
- Reference: Sutton & Balluffi, section 1.3.3.4; see also H. Grimmer, *Acta Cryst.*, **A30**, 685 (1974) for more detail.

Various Symmetry Combinations

- Fundamental zones in Rodrigues space:
 - (a) no sample symmetry with cubic crystal symmetry;
 - (b) orthorhombic sample symmetry (divide the space by 4 because of the 4 symmetry operators in 222), see next slide for details;
 - (c) cubic-cubic symmetry for disorientations.[after Neumann, 1991]

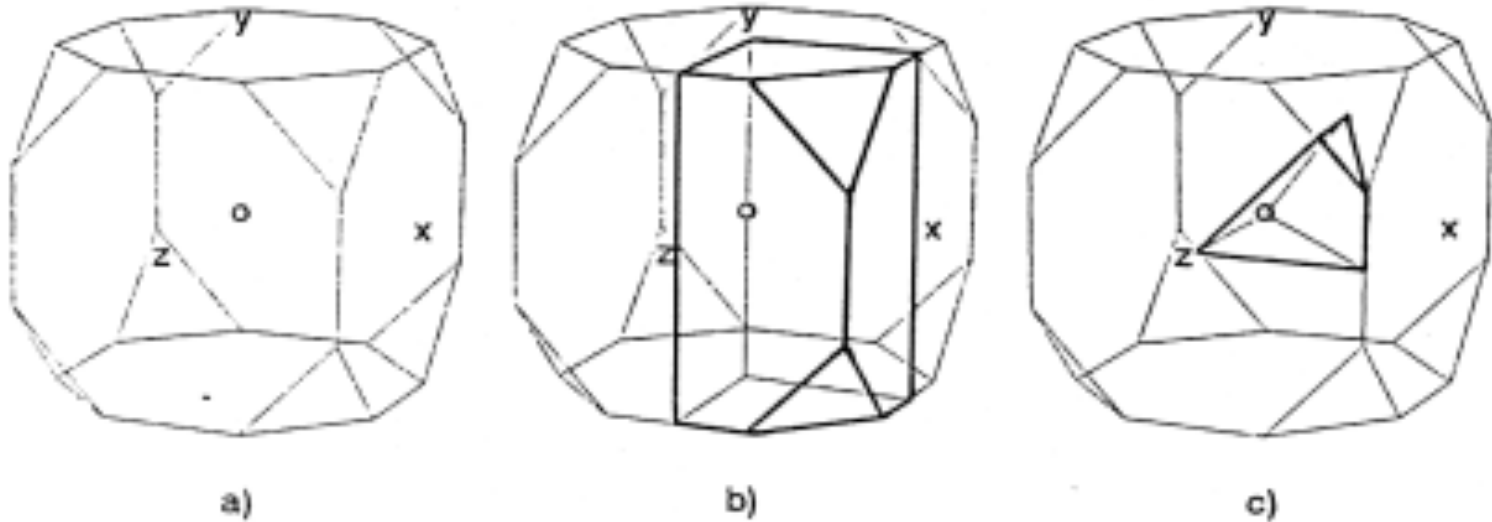

Effect of 2-fold Diads - schematic

Z-diad

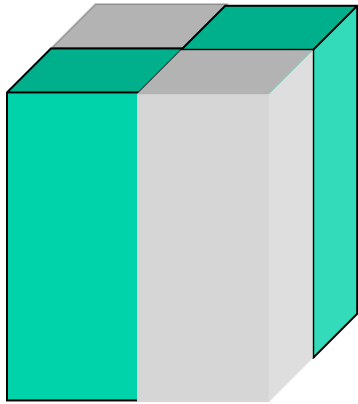

Y-diad

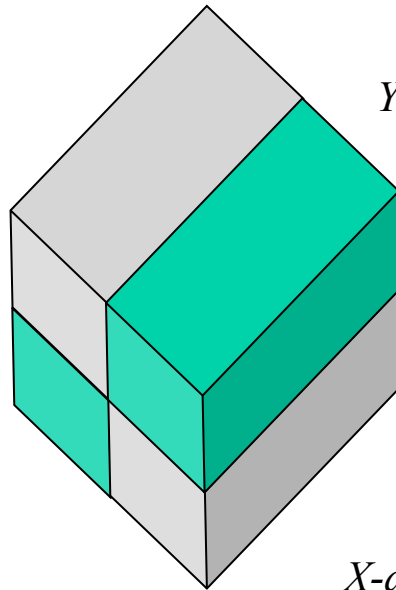

X-diad

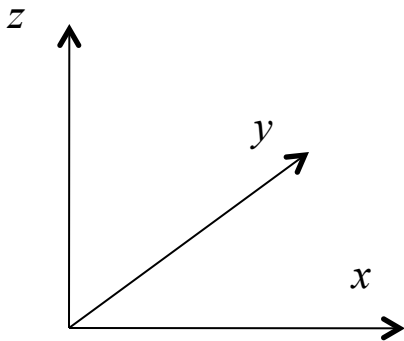
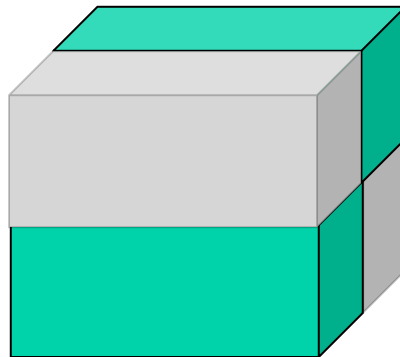

Green indicates region not excluded by the symmetry operator; when combining two operators, only the union of the green regions is kept.

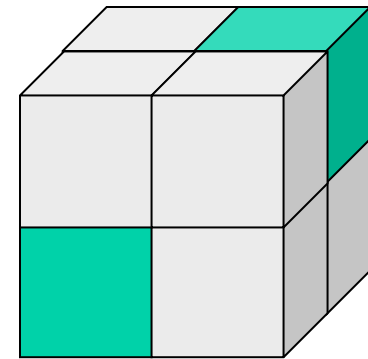

Y-diad + X-diad

or

Z-diad + X-diad

or

Y-diad + Z-diad

ANY combination of two diads leads to the same result.

Fundamental Zones for Orientations

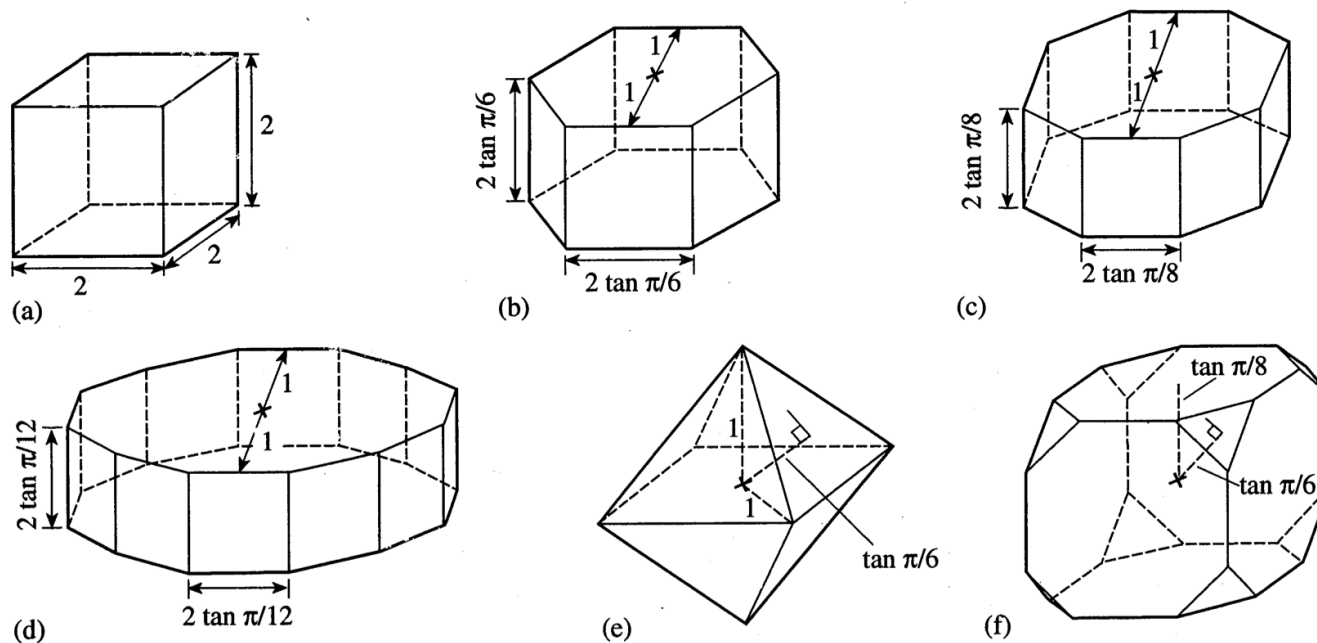

Fig. 1.5 The fundamental zones of the forms of closed polyhedra: (a) cube for the point groups 222 , $2mm$, mmm of the orthorhombic system; (b) hexagonal prism for 32 , $\bar{3}m$, $3m$ of the trigonal system; (c) octagonal prism for 422 , $4/m\bar{m}m$, $4mm$, and $\bar{4}2m$ of the tetragonal system; (d) dodecahedral prism for 622 , $6/m\bar{m}m$, $6mm$, and $\bar{6}m2$ of the hexagonal system; (e) octahedron for 23 and $m\bar{3}$ of the cubic system; (f) semiregular truncated cube for 432 , $m\bar{3}m$, and $\bar{4}3m$ of the cubic system.

[Sutton & Balluffi]

Maximum rotation angles: trigonal

- 3-fold axis on c (trigonal systems):

The coordinates of the point of interest (projection onto $R_3=0$ shown as a red dot) are:

$\{1, \tan(30^\circ), \tan(30^\circ)\} = \{1, 1/\sqrt{3}, 1/\sqrt{3}\}$. Distance from the origin = $\sqrt{[1+1/3+1/3]}$.

Corresponding maximum rotation angle = $2 \cdot \arctangent(\sqrt{1.6667}) = 2 \cdot 52.239^\circ = 104.475^\circ$

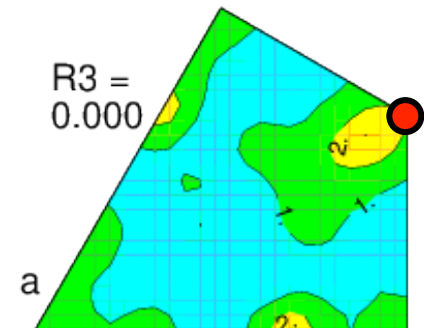
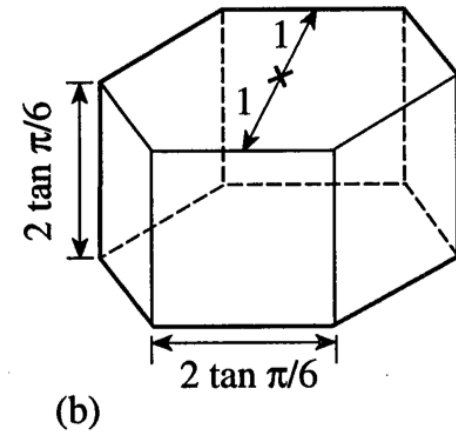

Rolling Texture Components for fcc in RF Space

- Note how many of the standard components are located, either in the $R_3=0$ plane, or at the top/bottom of the space.
- Note that the Cube appears only once, Goss appears twice, and Copper and Brass appear 4 times.

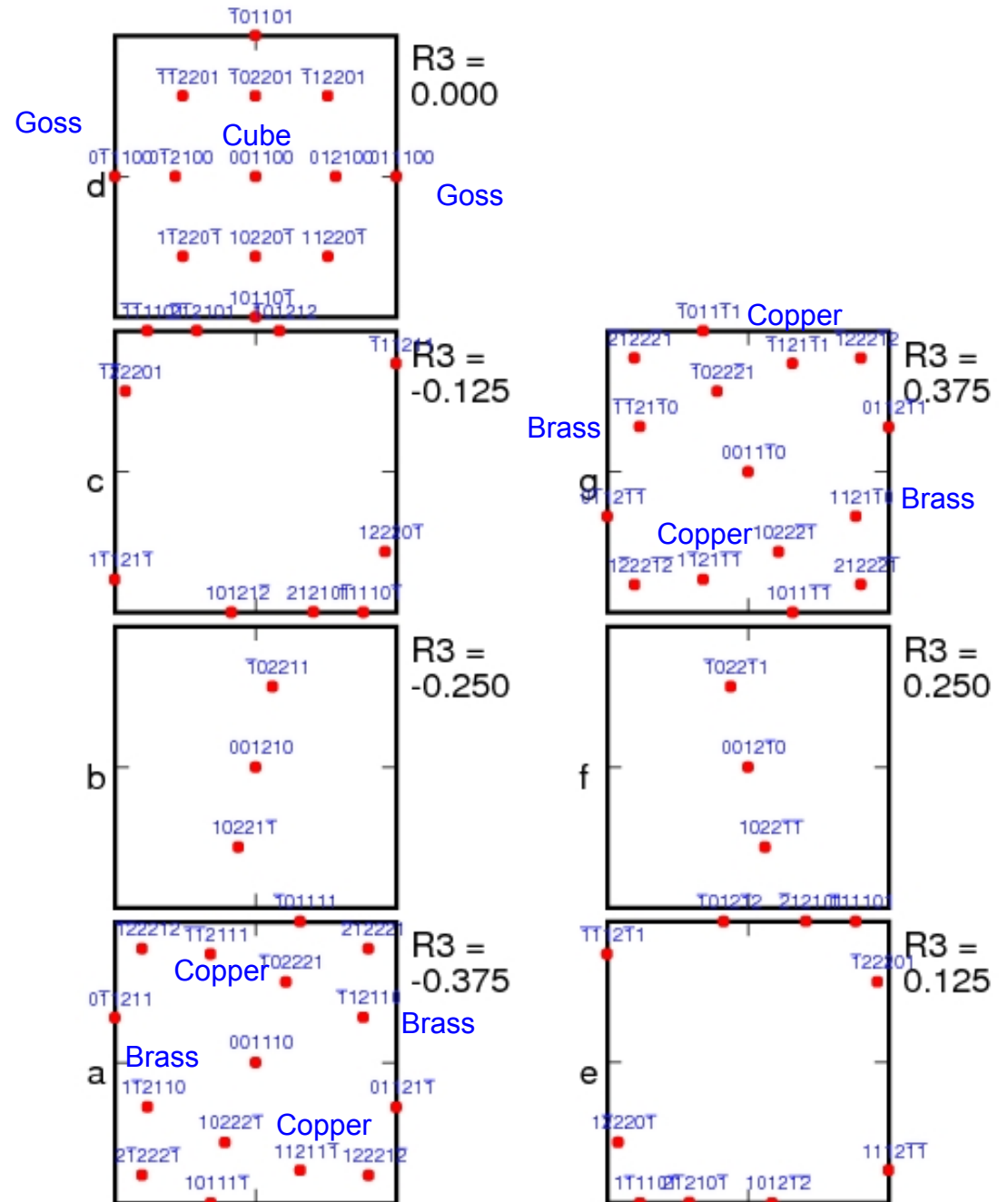

Disorientation

- Thanks to the crystal symmetry, no two cubic lattices can be different by more than 62.8° .
- Combining two orientations can lead to a rotation angle as high as 180° : applying crystal symmetry operators modifies the required rotation angle.
- Disorientation:= minimum rotation angle between two lattices, with the axis in the Standard Stereographic Triangle (SST).

Pseudo-code for Disorientation

```

! Work in crystal (local) frame
Calculate misorientation as  $g_B g_A^{-1}$ 
  For each ith crystal symmetry operator, calculate  $O_i g_B g_A^{-1}$ 
    For each jth crystal symmetry operator, calculate  $O_i g_B g_A^{-1} O_j$ 
      Test the axis for whether it lies in the FZ; repeat for inverse rotation
      If it does, test angle for whether it is lower than the previous minimum
      If new min. angle found, retain the result (with indices i & j)
    endif
  endif
enddo
enddo

```

Note that it is essential to test the axis in the outer loop and the angle in the inner loop, because it is often the case that the same (minimum) angle will be found for multiple rotation axes.

The “inverse rotation” can be easily obtained by negating the fourth (cosine) component of the quaternion.

Another view

- This gives another view of the Rodrigues space, with low-sigma value CSL locations noted.
- In this case, the $\langle 100 \rangle$ misorientations are located along the r^2 line.
- This also includes the locations of the most common Orientation Relationships found in phase transformations.

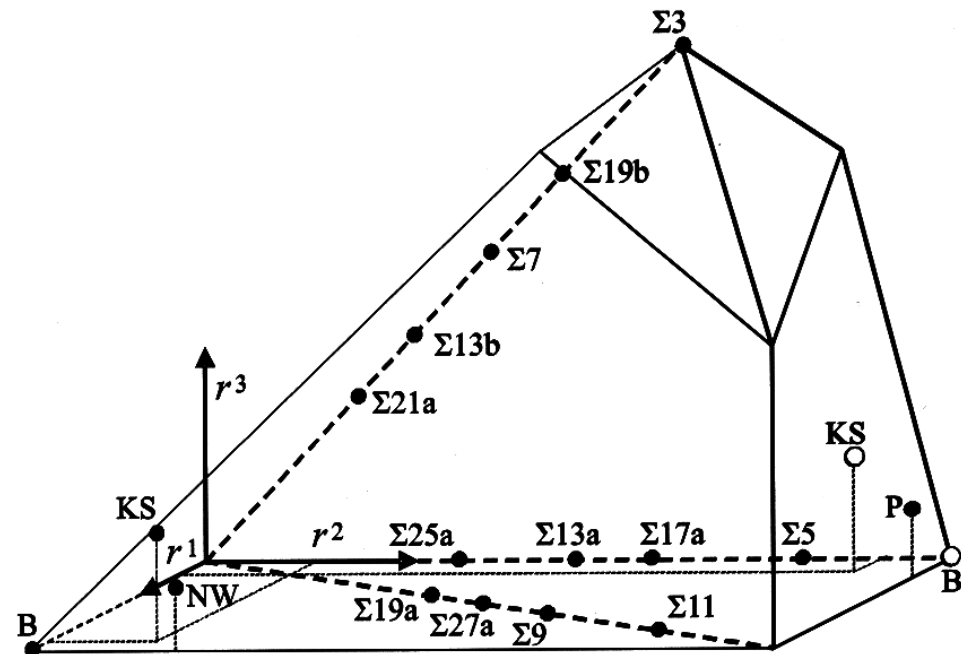

Fig. 9.3. The asymmetric domain for (O, O) (cubic-cubic) misorientations in Rodrigues space with locations of some CSL misorientations. A rotation representing a CSL is equivalent to its inverse, half of the domain for (O, O) is sufficient for showing CSL relationships. Such reduction is not allowed if orientation relationships between different phases are considered. The locations of Kurdjumov-Sachs (KS), Nishiyama-Wassermann (NW), Bain (B) and Pitsch (P) orientation relationships are also shown.

[Morawiec]

Table of
 CSL values
 in axis/
 angle, Euler
 angles,
 Rodrigues
 vectors
 and
 quaternions

| Σ | θ (°) | uv w | ϕ_1, Φ, ϕ_2 | | | ρ | | | q | | | |
|----------|--------------|---------|------------------------|-------|-------|--------|-------|-------|-------|-------|-------|-------|
| 3 | 60 | 111 | 45 | 70.53 | 45 | 0.333 | 0.333 | 0.333 | 0.288 | 0.288 | 0.288 | 0.866 |
| 5 | 36.86 | 100 | 0 | 90 | 36.86 | 0.333 | 0.000 | 0.000 | 0.000 | 0.000 | 0.316 | 0.948 |
| 7 | 38.21 | 111 | 26.56 | 73.4 | 63.44 | 0.199 | 0.199 | 0.199 | 0.188 | 0.188 | 0.188 | 0.944 |
| 9 | 38.94 | 110 | 26.56 | 83.62 | 26.56 | 0.25 | 0.25 | 0.000 | 0.000 | 0.236 | 0.236 | 0.943 |
| 11 | 50.47 | 110 | 33.68 | 79.53 | 33.68 | 0.333 | 0.333 | 0.000 | 0.000 | 0.302 | 0.302 | 0.904 |
| 13a | 22.62 | 100 | 0 | 90 | 22.62 | 0.2 | 0.000 | 0.000 | 0.000 | 0.000 | 0.196 | 0.981 |
| 13b | 27.79 | 111 | 18.43 | 76.66 | 71.57 | 0.143 | 0.143 | 0.143 | 0.139 | 0.139 | 0.139 | 0.971 |
| 15 | 48.19 | 210 | 19.65 | 82.33 | 42.27 | 0.400 | 0.200 | 0.000 | 0.000 | 0.183 | 0.365 | 0.913 |
| 17a | 28.07 | 100 | 0 | 90 | 28.07 | 0.250 | 0.000 | 0.000 | 0.000 | 0.000 | 0.243 | 0.970 |
| 17b | 61.9 | 221 | 45 | 86.63 | 45 | 0.4 | 0.4 | 0.2 | 0.171 | 0.343 | 0.343 | 0.858 |
| 19a | 26.53 | 110 | 18.44 | 89.68 | 18.44 | 0.166 | 0.166 | 0.000 | 0.000 | 0.162 | 0.162 | 0.973 |
| 19b | 46.8 | 111 | 33.69 | 71.59 | 56.31 | 0.25 | 0.25 | 0.25 | 0.229 | 0.229 | 0.229 | 0.918 |
| 21a | 21.78 | 111 | 14.03 | 79.02 | 75.97 | 0.111 | 0.111 | 0.111 | 0.109 | 0.109 | 0.109 | 0.982 |
| 21b | 44.41 | 211 | 22.83 | 79.02 | 50.91 | 0.333 | 0.167 | 0.167 | 0.154 | 0.154 | 0.308 | 0.926 |
| 23 | 40.45 | 311 | 15.25 | 82.51 | 52.13 | 0.334 | 0.111 | 0.111 | 0.104 | 0.104 | 0.313 | 0.938 |
| 25a | 16.26 | 100 | 0 | 90 | 16.26 | 0.143 | 0.000 | 0.000 | 0.000 | 0.000 | 0.142 | 0.99 |
| 25b | 51.68 | 331 | 36.87 | 90 | 53.13 | 0.333 | 0.333 | 0.111 | 0.100 | 0.300 | 0.300 | 0.9 |
| 27a | 31.59 | 110 | 21.8 | 85.75 | 21.8 | 0.200 | 0.200 | 0.000 | 0.000 | 0.193 | 0.193 | 0.962 |
| 27b | 35.43 | 210 | 15.07 | 85.75 | 31.33 | 0.285 | 0.143 | 0.000 | 0.000 | 0.136 | 0.272 | 0.953 |
| 29a | 43.6 | 100 | 0 | 90 | 43.6 | 0.400 | 0.000 | 0.000 | 0.000 | 0.000 | 0.393 | 0.928 |
| 29b | 46.4 | 221 | 33.69 | 84.06 | 56.31 | 0.286 | 0.286 | 0.143 | 0.131 | 0.263 | 0.263 | 0.919 |
| 31a | 17.9 | 111 | 11.31 | 80.72 | 78.69 | 0.091 | 0.091 | 0.091 | 0.09 | 0.09 | 0.09 | 0.988 |
| 31b | 52.2 | 211 | 27.41 | 78.84 | 43.66 | 0.4 | 0.2 | 0.2 | 0.180 | 0.18 | 0.359 | 0.898 |
| 33a | 20.1 | 110 | 12.34 | 83.04 | 58.73 | 0.125 | 0.125 | 0.000 | 0.000 | 0.123 | 0.123 | 0.985 |
| 33b | 33.6 | 311 | 37.51 | 76.84 | 37.51 | 0.273 | 0.091 | 0.091 | 0.087 | 0.087 | 0.261 | 0.957 |
| 33c | 59.0 | 110 | 38.66 | 75.97 | 38.66 | 0.4 | 0.4 | 0.000 | 0.000 | 0.348 | 0.348 | 0.870 |
| 35a | 34.0 | 211 | 16.86 | 80.13 | 60.46 | 0.25 | 0.125 | 0.125 | 0.119 | 0.119 | 0.239 | 0.956 |
| 35b | 43.2 | 331 | 30.96 | 88.36 | 59.04 | 0.272 | 0.272 | 0.091 | 0.083 | 0.253 | 0.253 | 0.93 |
| | | | | | | | | | | | | |

Sigma-9 values for Rodrigues
 vector and quaternion corrected
 10th May 2007

Rodrigues vector normalization

- The volume element, or Haar measure, in Rodrigues space is given by the following formula [$\rho = \tan(\theta/2)$]:

$$d(\Delta g) = \left(\frac{1}{\pi}\right) \left(\frac{\rho}{1 + \rho^2}\right)^2 d\rho d\hat{n}$$

$$d(\Delta g) =$$

- Can also write in terms of an azimuth, χ , and declination, ζ , angles:

$$\left(\frac{\rho}{1 + \rho^2}\right)^2 d\rho \sin \chi d\chi d\zeta$$

- And finally in terms of R_1, R_2, R_3 :

$$d(\Delta g) = \left(\frac{1}{\pi^2}\right) \left(\frac{1}{1 + \rho^2}\right)^2 dR_1 dR_2 dR_3$$

$$\rho = \sqrt{R_1^2 + R_2^2 + R_3^2} = \tan \theta / 2;$$

$$\zeta = \tan^{-1} R_2 / R_1; \quad dn = \sin \chi d\chi d\zeta;$$

$$\chi = \cos^{-1} R_3;$$

$$\rho^2 = R_1^2 + R_2^2 + R_3^2$$

Density in the SST

- Density or % in area

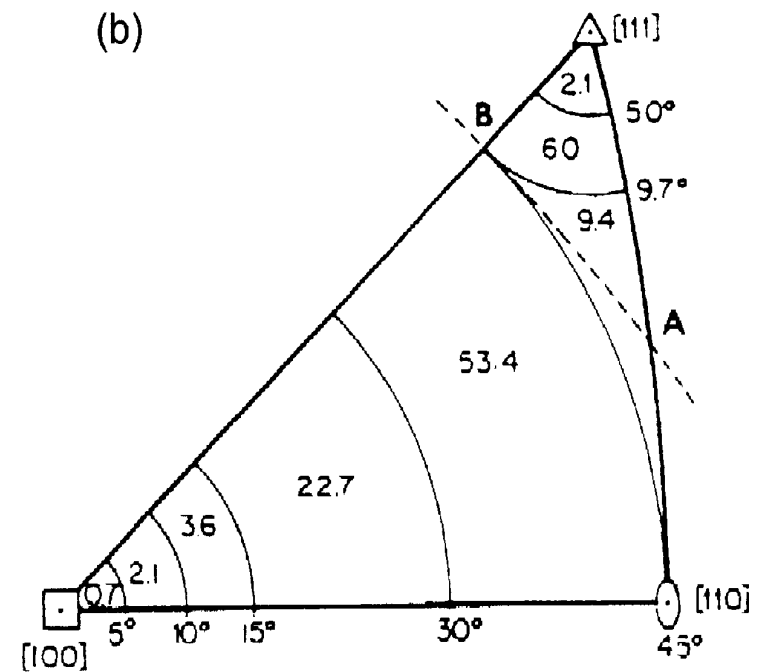
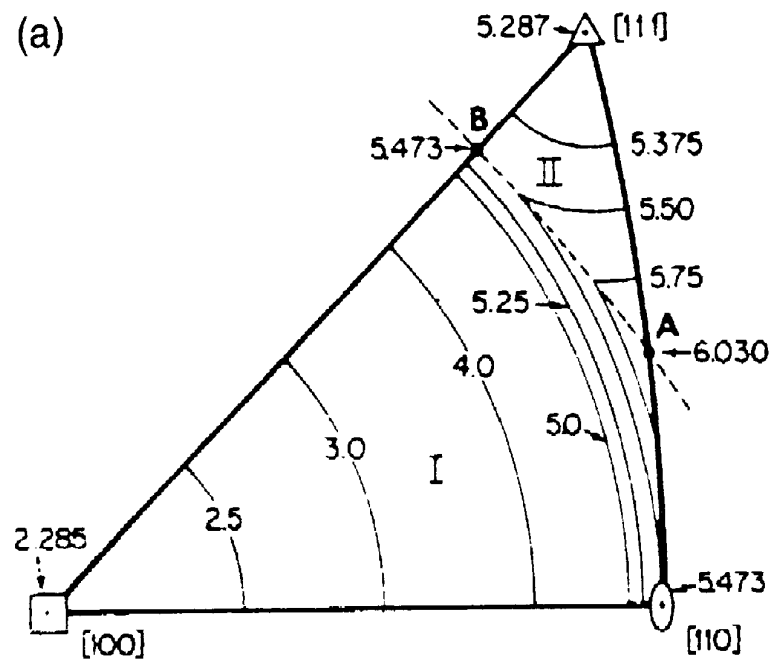

J.K. Mackenzie 1958

ID of symmetry operator(s)

- For calculations (numerical) on grain boundary character, it is critical to retain the identity of each symmetry operator use to place a given grain boundary in the FZ.
- That is, given $O_c \in O(432) = O_i \{O_1, O_2, \dots, O_{24}\}$ one must retain the value of index “ i ” for subsequent use, e.g. in determining tilt/twist character.

Successive misorientations

- There are problems where one needs to calculate the effect of two successive misorientations, taking into account variants. By “variants” we mean that the second misorientation (twin) can occur on any of the systems related by crystal symmetry. For example, if twinning occurs on more than one system, then the second twin can be physically contained within the first twin but still make a boundary with the original matrix. So, the problem is, how do we calculate the matrix-twin₂ misorientation, taking account of crystal symmetry and the possibility of (crystal) symmetry-related variants?

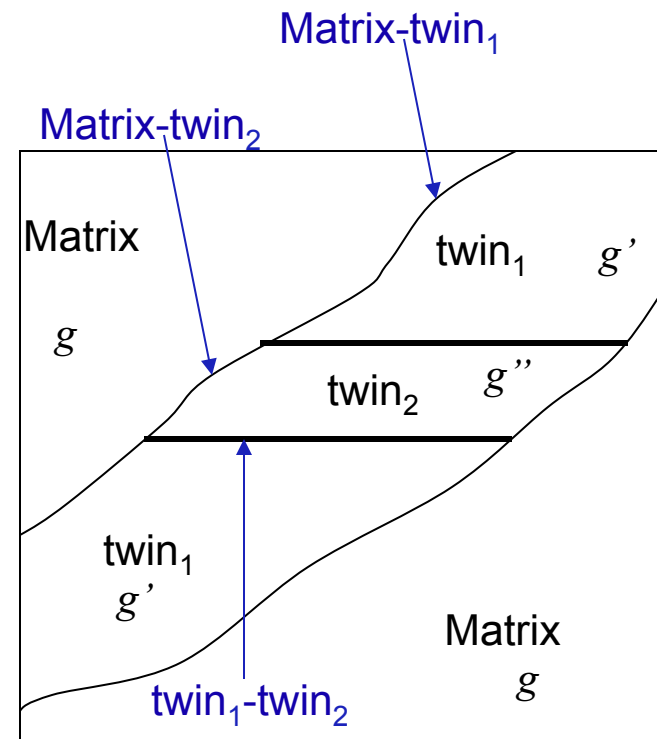

Successive Twins

- The key to this problem is to recognize that (a) the order of the two twins/misorientations does not matter, and (b) that one must insert an additional (crystal) symmetry element between the two twins/misorientations. In effect one treats each twin/misorientation (T) as a rotation (or orientation). The same procedure can be used for phase transformations, although one must be careful about the difference between going from phase 1 to phase 2, versus 2 to 1. We obtain a set of physically equivalent orientations, $\{g''\}$, starting from a matrix orientation, g , thus:
 - $\{g''\} = (O_c T_2) O_c (O_c T_1) g = O_c T_2 O_c T_1 g.$
 - Note the presence of symmetry operators pre-multiplying, as well the additional symmetry operator in between the two misorientations. This additional symmetry operator is applied in a manner that is equivalent to *sample symmetry*.
 - Curiously, the order in which the twins/misorientations are applied does not make any difference, for the three types of twins considered here (for Ti). The overall misorientation for matrix \rightarrow twin₁ \rightarrow twin₂ is the same as matrix \rightarrow twin₂ \rightarrow twin₁. The reason for this not very obvious result is the fact that the rotation axes coincide with mirror planes in the crystal symmetry. Accordingly, this is not a general result.
 - Thanks to Nathalie Bozzolo (Univ. Metz) for pointing out this problem.
 - For a (much) more detailed analysis of *twin chains*, see papers by Cayron.

Successive twins: simple example

- First let's illustrate how this works with the first misorientation as 60° about 100, and the second as 15° , also about 100. We use hexagonal crystal symmetry so that we can view the 0001 pole figure and easily interpret the results. What we expect to see is that the second misorientation (twin, if you like) "decorates" the first twin, by producing additional, small changes in position relative to the first one. In this example, the two symmetry operators that are normally used to apply crystal symmetry to calculate disorientation have been omitted. If only the first misorientation of 60° had been applied, there would be only one pole in the 0001 pole figure (at the center of the ring of six poles that you see).

Filename root: rexgbs_Eulers_



Stereographic

$$\{\Delta g\} = T_2 O_c T_1$$

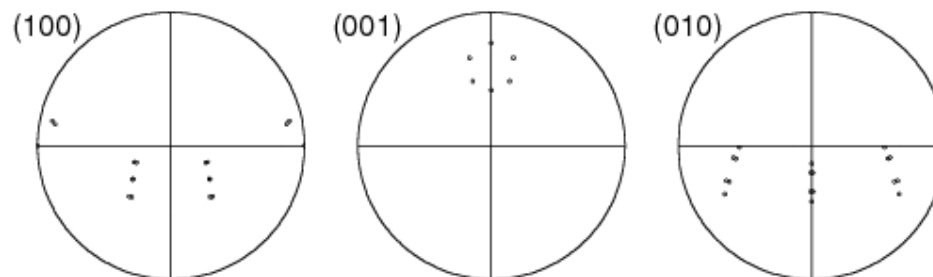

Successive twins: simple example

- Now let's add all the symmetry operators so that we see all the possible variants. Now there are six rings of six poles in the 0001 pole figure. Remember: pole figures of pairs of successive twins vary with the order in which the twins are applied, even though the misorientations remain the same.

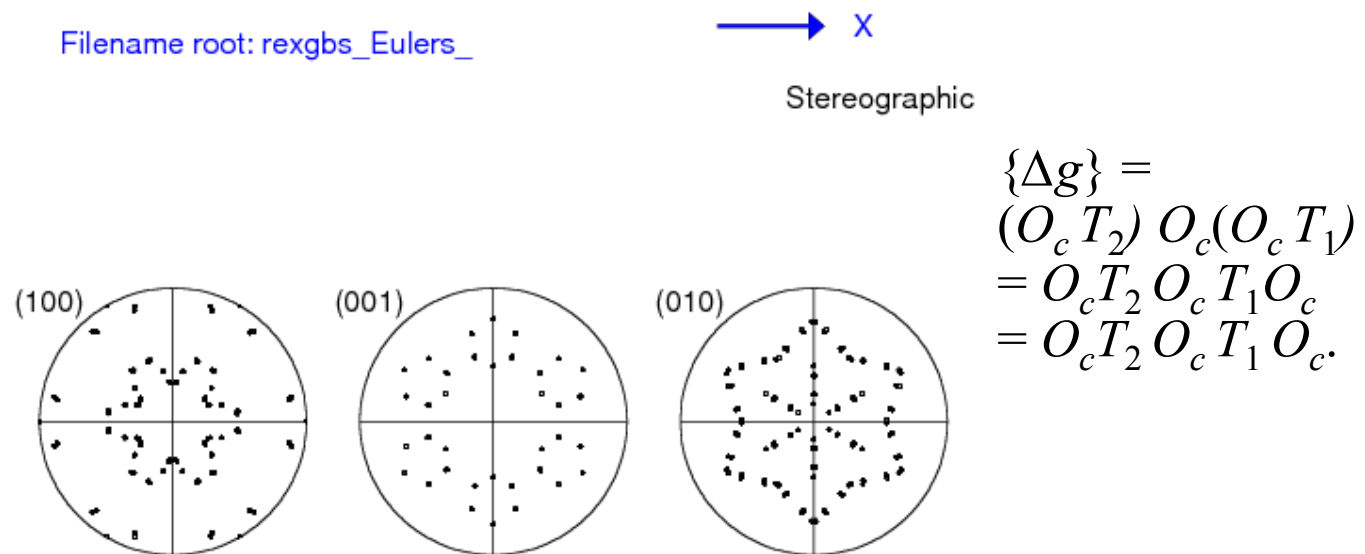

Successive twins: Zr, CT-TT2

- This illustrates the result for a hexagonal system (Zr) with the two twins,
 - a) tensile twins (twin_2)
(TT2 type ; close to σ_{11a} ; $35.1^\circ \langle 10\text{-}10 \rangle$)
 - b) inside compressive twins (twin_1)
(CT type; close to σ_{7b} ; $64.6^\circ \langle 10\text{-}10 \rangle$)
- The results are illustrated first as pole figures, in order to make sure that the calculations are performed correctly.

Filename root: rexgbs_Eulers_



Stereographic

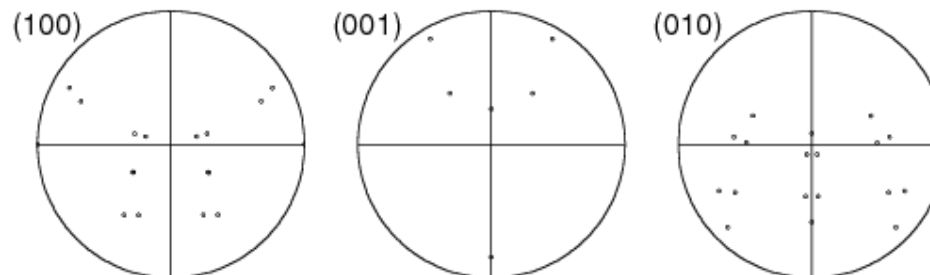

Successive twins: Zr, CT-TT2

- Now we add all the symmetry operators so that we see the full effect. Note that the two twins share the same axis and that the two angles add up to almost exactly 100° , so there are many near coincidences in the pole positions.

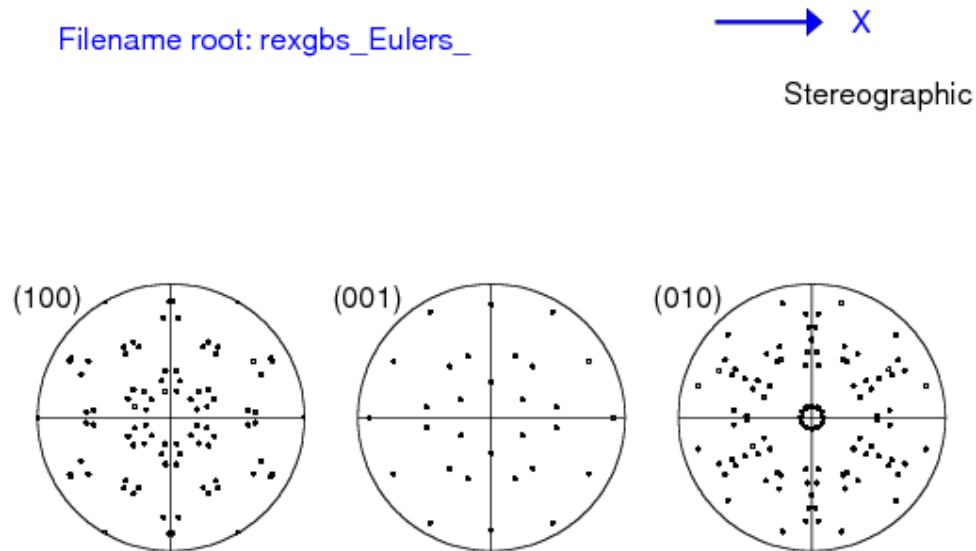

Successive twins: Zr, CT- TT2

- Now we plot the misorientations that result from this pair.
- These are the misorientations between the matrix and the second twin. The combination produces new misorientations, relative to the two twins.

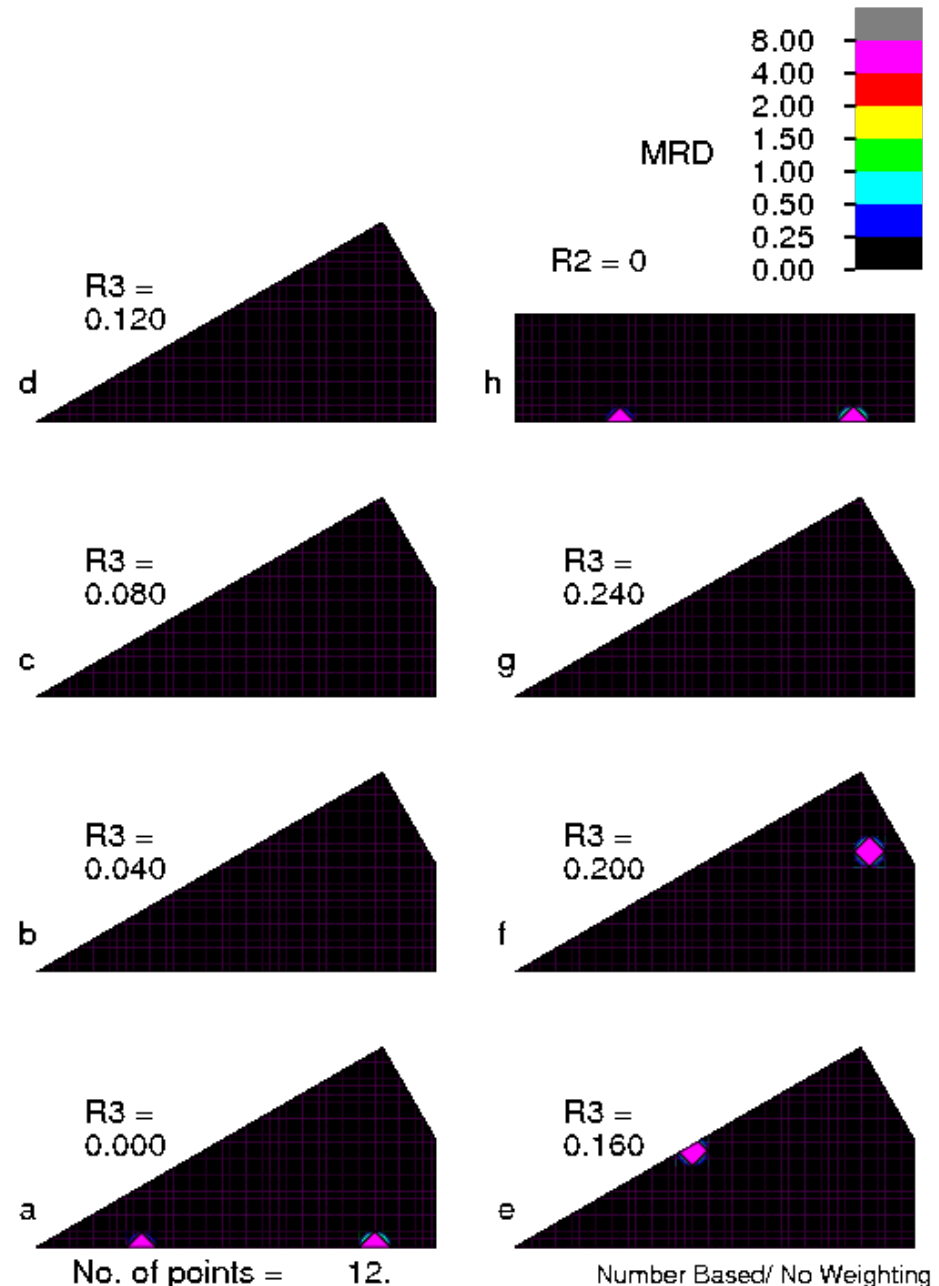

Add chains of CT, TT1 ...; add the second cut for R1=0
 Caution: R1 is Cartesian X₁ = 2110 (the a-axis) for the X-convention
 or 1010 for the Y-conventionS

Successive twins: Zr, TT2-CT

- The twin chain TT2 *then* CT produces a slightly different result in terms of pole figures. The misorientations, however, are the same.

Filename root: rexgbs_Eulers_



Stereographic

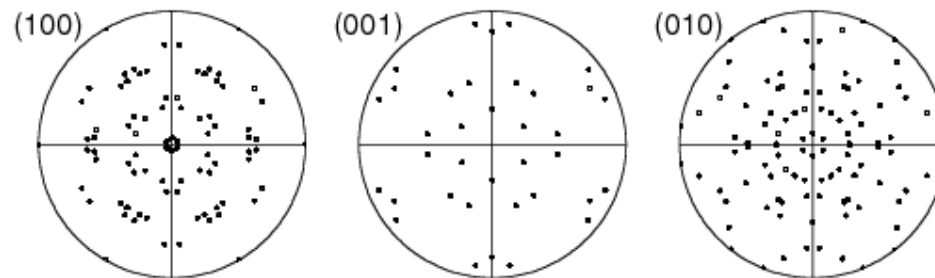

Order of twins, PFs, Δg

- We can understand the reason for the pole figures depending on the order of the twins, but not the misorientation as follows. Pole figures show us what is going on with respect to the sample frame. Given that two rotations do not commute, it is not surprising that the net result is different: see below for 60° about 100 , followed by 15° about each of the equivalent 100 axes in the intermediate frame. The other figure shows 15° followed by 60° , again for all equivalent 100 axes in the intermediate frame.

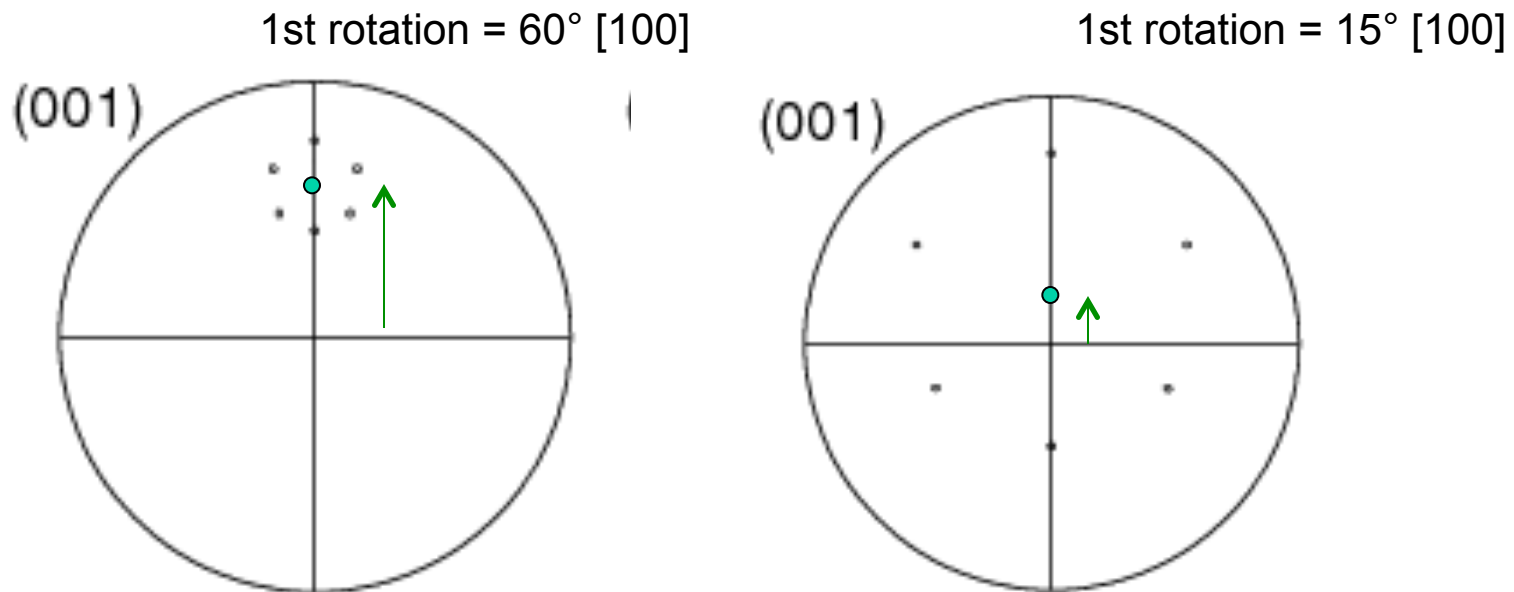

Order of twins, PFs, Δg , contd.

- In order to understand why, in this particular case, the order of the twins does not matter, consider the fact that the twin/rotation axis is coincident with one of the 2-fold symmetry operators in the hexagonal point group.
- The consequence of this is that, although the forward twin is obviously different from the negative twin, the set of twin variants produced by the twin is the same, regardless of whether rotates in the positive or negative sense.
- In mathematical terms, this means the following (note the "=", meaning that the sets are the same):
 - $\{O_c T_2\} = \{O_c T_2^{-1}\}$
 - Recall also the physical equivalence between the forward (positive) and the backward (negative) misorientation across a boundary:
 - $\Delta g \equiv \Delta g^{-1}$

Order of twins, PFs, Δg , contd.

- $\Delta g = O_c T_2 O_c T_1 O_c \equiv O_c T_1^{-1} O_c T_2^{-1} O_c$
- What we want is the set of transformations that represent the boundary:

$$\{\Delta g\} = \{\Delta g_{12}\} \cup \{\Delta g_{21}\}$$
- Using the equality noted above:
- $$\begin{aligned} \{\Delta g\} &= \{O_c T_2 O_c T_1 O_c\} \cup \{O_c T_1^{-1} O_c T_2^{-1} O_c\} \\ &= \{O_c T_2 O_c T_1 O_c\} \cup \{O_c T_1 O_c T_2 O_c\} \end{aligned}$$
- This demonstrates (Q.E.D.) that the order of the twins does not matter, **provided that the twins both coincide with a crystal symmetry element** such that the forward and backward rotations (with all their variants) yield the same set of results.